

HI 83203

Multiparameter Bench Photometer for Aquaculture

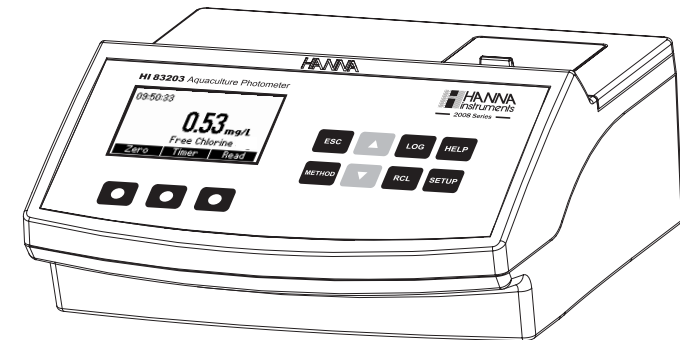

Dear Customer,

Thank you for choosing a Hanna product. Please read this instruction manual carefully before using the instrument. This manual will provide you with the necessary information for the correct use of the instrument. If you need additional technical information, do not hesitate to e-mail us at tech@hannainst.com. This instrument is in compliance with **CE** directives.

TABLE OF CONTENTS

PRELIMINARY EXAMINATION	3
ABBREVIATIONS	3
GENERAL DESCRIPTION	3
SPECIFICATIONS	4
PRECISION AND ACCURACY	4
PRINCIPLE OF OPERATION	4
FUNCTIONAL DESCRIPTION	6
NEED TO KNOW	7
TIPS FOR AN ACCURATE MEASUREMENT	7
HEALTH & SAFETY	10
METHOD REFERENCE TABLE	10
OPERATIONAL GUIDE	11
SETUP	13
HELP MODE	15
AMMONIA MR	16
AMMONIA LR	18
FREE CHLORINE	20
TOTAL CHLORINE	23
COPPER HR	26
COPPER LR	28
NITRATE	30
NITRITE HR	32
NITRITE LR	34
DISSOLVED OXYGEN	36
pH	38
PHOSPHATE HR	40
PHOSPHATE LR	42
ERRORS AND WARNINGS	44
DATA MANAGEMENT	45
STANDARD METHODS	45
ACCESSORIES	46
WARRANTY	47
HANNA LITERATURE	47

All rights are reserved. Reproduction in whole or in part is prohibited without the written consent of the copyright owner, Hanna Instruments Inc., Woonsocket, Rhode Island, 02895, USA.

PRELIMINARY EXAMINATION

Please examine this product carefully. Make sure that the instrument is not damaged. If any damage occurred during shipment, please notify your Dealer.

Each Meter is supplied complete with:

- Two Sample Cuvettes and Caps
- Cloth for wiping cuvettes (4 pcs)
- Scissors
- AC/DC Power Adapter
- Instruction Manual
- Rigid carrying case

Note: Save all packing material until you are sure that the instrument works correctly. Any defective item must be returned in its original packing with the supplied accessories.

ABBREVIATIONS

°C:	degree Celsius
EPA:	US Environmental Protection Agency
°F:	degree Fahrenheit
g/L:	grams per liter (ppt)
HR:	high range
LR:	low range
mg/L:	milligrams per liter (ppm)
mL:	milliliter
MR:	medium range
µg/L:	micrograms per liter (ppb)
PAN:	1-(2-pyridylazo)-2-naphthol
TPTZ:	2,4,6-tri-(2-pyridyl)-1,3,5-triazine

GENERAL DESCRIPTION

HI 83203 is a multiparameter bench photometer dedicated for Aquaculture analysis. It can measure 13 different methods using specific liquid or powder reagents. The amount of reagent is precisely dosed to ensure maximum reproducibility.

HI 83203 bench photometer can be connected to a PC via an USB cable. The optional **HI 92000** Windows® Compatible Software helps users manage all their results.

SPECIFICATIONS

Light Life	Life of the instrument
Light Detector	Silicon Photocell
Environment	0 to 50°C (32 to 122°F); max 90% RH non-condensing
Power Supply	external 12 Vdc power adapter built-in rechargeable battery
Dimensions	235 x 200 x 110 mm (9.2 x 7.87 x 4.33")
Weight	0.9 Kg

For specifications related to each method (e.g. range, precision, etc.) refer to the related measurement section.

PRECISION AND ACCURACY

Precision is how closely repeated measurements agree with each other. Precision is usually expressed as standard deviation (SD).

Accuracy is defined as the nearness of a test result to the true value.

Although good precision suggests good accuracy, precise results can be inaccurate. The figure explains these definitions.

For each method, the precision is expressed in the related measurement section as standard deviation at a specific concentration value of the analite. The standard deviation is obtained with a single instrument using a representative lot of reagents.

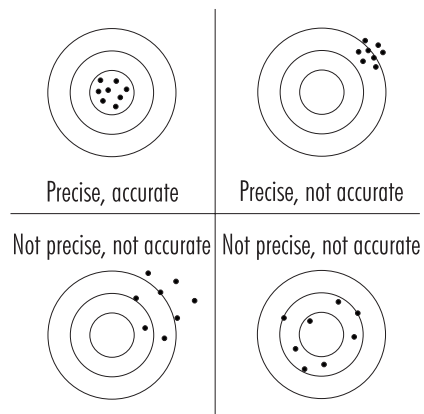

PRINCIPLE OF OPERATION

Absorption of Light is a typical phenomenon of interaction between electromagnetic radiation and matter. When a light beam crosses a substance, some of the radiation may be absorbed by atoms, molecules or crystal lattices.

If pure absorption occurs, the fraction of light absorbed depends both on the optical path length through the matter and on the physical-chemical characteristics of substance according to the Lambert-Beer Law:

$$-\log \frac{I}{I_0} = \epsilon_{\lambda} c d$$

or

$$A = \epsilon_{\lambda} c d$$

Where:

- $-\log \frac{I}{I_0}$ = Absorbance (A)
- I_0 = intensity of incident light beam
- I = intensity of light beam after absorption
- ϵ_{λ} = molar extinction coefficient at wavelength λ
- c = molar concentration of the substance
- d = optical path through the substance

Therefore, the concentration "c" can be calculated from the absorbance of the substance as the other factors are known.

Photometric chemical analysis is based on the possibility to develop an absorbing compound from a specific chemical reaction between sample and reagents.

Given that the absorption of a compound strictly depends on the wavelength of the incident light beam, a narrow spectral bandwidth should be selected as well as a proper central wavelength to optimize measurements.

The optical system of **HI 83203** is based on special subminiature tungsten lamps and narrow-band interference filters to guarantee both high performance and reliable results.

Five measuring channels (at five different wavelengths) allow a wide range of tests.

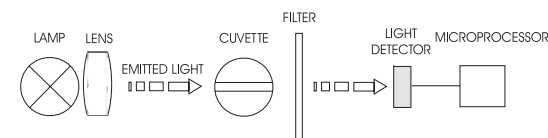

Instrument block diagram (optical layout)

A microprocessor controlled special tungsten lamp emits radiation which is first optically conditioned and beamed to the sample contained in the cuvette. The optical path is fixed by the diameter of the cuvette. Then the light is spectrally filtered to a narrow spectral bandwidth, to obtain a light beam of intensity $-I_0$ or $-I-$.

The photoelectric cell collects the radiation $-I-$ that is not absorbed by the sample and converts it into an electric current, producing a potential in the mV range.

The microprocessor uses this potential to convert the incoming value into the desired measuring unit and to display it on the LCD.

The measurement process is carried out in two phases: first the meter is zeroed and then the actual measurement is performed.

The cuvette has a very important role because it is an optical element and thus requires particular attention. It is important that both the measurement and the calibration (zeroing) cuvette are optically identical to provide the same measurement conditions. Most of methods use the same cuvette for both, so it is important that measurements take place in the same optical point. The instrument and the cuvette cap have special marks that must be aligned in order to obtain better reproducibility.

The surface of the cuvette must be clean and not scratched. This is to avoid measurement interference due to unwanted reflection and absorption of light. It is recommended not to touch the cuvette walls with hands.

Furthermore, in order to maintain the same conditions during the zeroing and the measurement phases, it is necessary to close the cuvette to prevent any contamination.

FUNCTIONAL DESCRIPTION



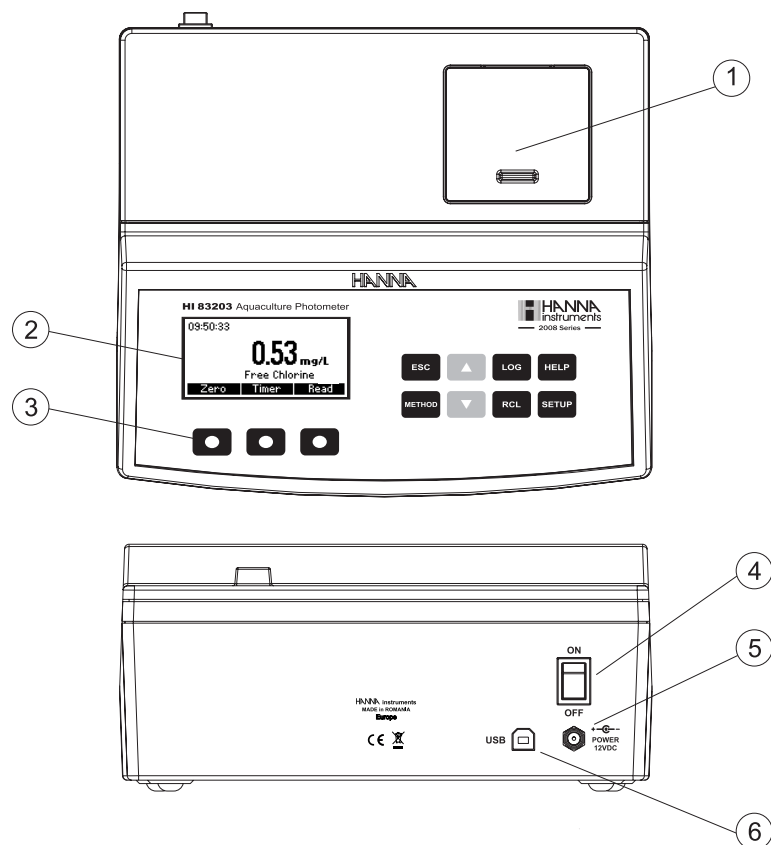





INSTRUMENT DESCRIPTION



- 1) Cuvette Lid
- 2) Liquid Crystal Display (LCD).
- 3) Splash proof keypad.
- 4) ON/OFF power switch
- 5) Power input connector
- 6) USB connector

KEYPAD DESCRIPTION

The keypad contains 8 direct keys and 3 functional keys with the following functions:

-  Press to perform the function displayed above it. The functions are screen related.
-  Press to exit the current screen.
-  Press to access the select method menu.
-  Press to move up in a menu or a help screen, to increment a set value, to access second level functions.
-  Press to move down in a menu or a help screen, to decrement a set value, to access second level functions.
-  Press to log the current reading.
-  Press to recall the log.
-  Press to display the help screen.
-  Press to access the setup screen.

NEED TO KNOW

HI 83203 has a powerful interactive user support that assists the user during the analysis process. Each step in the measurement process is help supported. A tutorial mode is available in the Setup Menu.

TIPS FOR AN ACCURATE MEASUREMENT

The instructions listed below should be carefully followed during testing to ensure most accurate results.

- Color or suspended matter in large amounts may cause interference, they should be removed by treatment with active carbon and filtration.
- Ensure the cuvette is filled correctly: the liquid in the cuvette forms a convexity on the top; the bottom of this convexity must be at the same level of the 10 mL mark.

COLLECTING AND MEASURING SAMPLES

- In order to measure exactly 0.5 mL of reagent with the 1 mL syringe:
 - (a) push the plunger completely into the syringe and insert the tip into the solution.
 - (b) pull the plunger up until the lower edge of the seal is exactly on the 0.0 mL mark.

- (c) take out the syringe and clean the outside of the syringe tip. Be sure that no drops are hanging on the tip of the syringe, if so eliminate them. Then, keeping the syringe in vertical position above the cuvette, push the plunger down into the syringe until the lower edge of the seal is exactly on the 0.5 mL mark. Now the exact amount of 0.5 mL has been added to the cuvette, even if the tip still contains some solution.

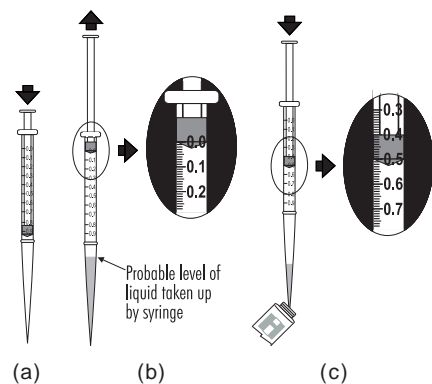

USING LIQUID AND POWDER REAGENTS

- Proper use of the dropper:
 - for reproducible results, tap the dropper on the table for several times and wipe the outside of the dropper tip with a cloth.
 - always keep the dropper bottle in a vertical position while dosing the reagent.

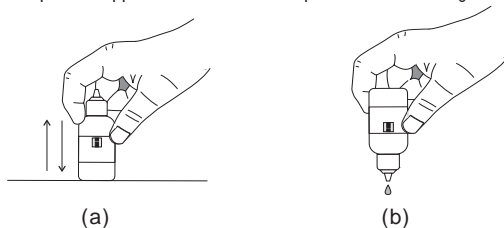

- Proper use of the powder reagent packet:
 - use scissors to open the powder packet;
 - push the edges of the packet to form a spout;
 - pour out the content of the packet.

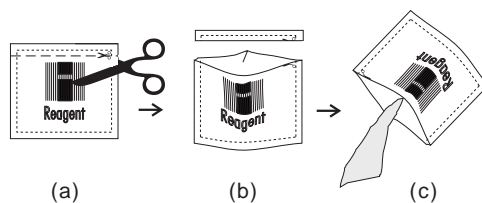

USING CUVETTES

- Proper mixing of the cuvette is done by **shaking the cuvette**, moving the cuvette up and down. The movement may be gentle or vigorous. This mixing method is indicated with “shake gently” or “shake vigorously”, and one of the following icons:

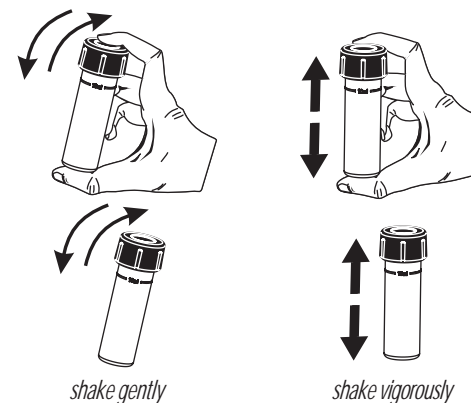

Pay attention to push the cuvette completely down in the holder.

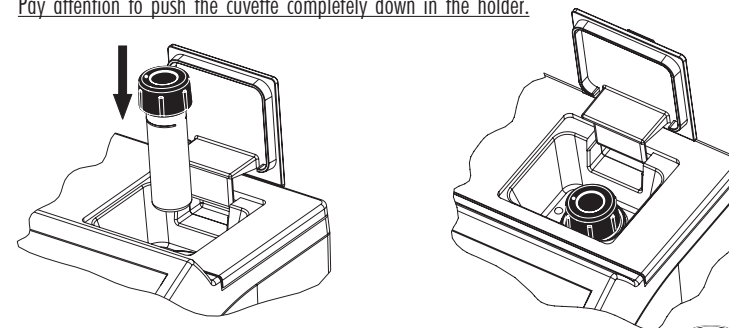

- In order to avoid reagent leaking and to obtain more accurate measurements, close the cuvette first with the supplied HDPE plastic stopper and then the black cap.
- Each time the cuvette is used, the cap must be tightened to the same degree.
- Whenever the cuvette is placed into the measurement cell, it must be dry outside, and free of fingerprints, oil or dirt. Wipe it thoroughly with HI 731318 or a lint-free cloth prior to insertion.
- Shaking the cuvette can generate bubbles in the sample, causing higher readings. To obtain accurate measurements, remove such bubbles by swirling or by gently tapping the cuvette.
- Do not let the reacted sample stand too long after reagent is added, or accuracy will be lost.

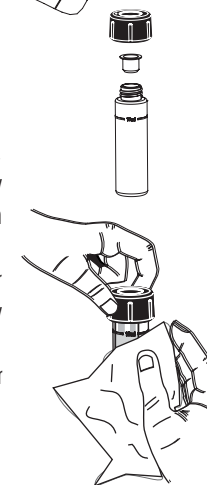

- It is possible to take multiple readings in a row, but it is recommended to take a new zero reading for each sample and to use the same cuvette for zeroing and measurement when possible (for most precise results follow the measurement procedures carefully).
- Discard the sample immediately after the reading is taken, or the glass might become permanently stained.
- All the reaction times reported in this manual are at 20°C (68°F). As a general rule of thumb, they should be doubled at 10°C (50°F) and halved at 30°C (86°F).

REAGENT BLANK CORRECTION

- Some methods require a “reagent blank correction”. The blank and the sample are prepared exactly in the same way, only the blank is deionized water instead of sample.
A blank cuvette may be used more than once: stability and storing conditions are described for each method in the related chapter.

INTERFERENCES

- In the method measurement section the most common interferences that may be present in an average wastewater matrix have been reported. It may be that for a particular treatment process other compounds do interfere with the method of analysis.

HEALTH & SAFETY



The chemicals contained in the reagent kits may be hazardous if improperly handled. Read the Material Safety Data Sheet (MSDS) before performing tests.

Safety equipment: Wear suitable eye protection and clothing when required, and follow instructions carefully.

Reagent spills: If a reagent spill occurs, wipe up immediately and rinse with plenty of water.

If reagent contacts skin, rinse the affected area thoroughly with water. Avoid breathing released vapors.

METHOD REFERENCE TABLE

HI 83203 - AQUACULTURE

Method	Method description	Page
1	Ammonia MR	16
2	Ammonia LR	18
3	Free Chlorine	20
4	Total Chlorine	23
5	Copper HR	26
6	Copper LR	28
7	Nitrate	30

Method	Method description	Page
8	Nitrite HR	32
9	Nitrite LR	34
10	Dissolved Oxygen	36
11	pH	38
12	Phosphate HR	40
13	Phosphate LR	42

OPERATIONAL GUIDE

POWER CONNECTION AND BATTERY MANAGEMENT

The meter can be powered from an AC/DC adapter (included) or from the built-in rechargeable battery.

Note: Always turn the meter off before unplugging it to ensure no data is lost.

When the meter switches ON, it verifies if the power supply adapter is connected. The battery icon on the LCD will indicate the battery status:

- battery is charging from external adapter
- battery fully charged (meter connected to AC/DC adapter)

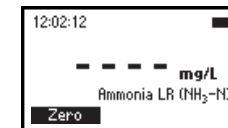
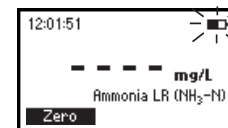

- battery capacity (no external adapter)

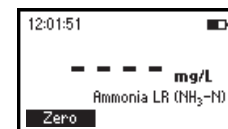

- battery Low (no external adapter)

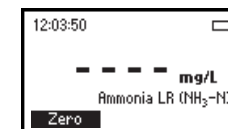

- battery Dead (no external adapter)



METHOD SELECTION

- Turn ON the instrument via the ON/OFF power switch.
- The meter will perform an autodiagnostic test. During this test, the Hanna Instrument logo will appear on the LCD. After 5 seconds, if the test was successful, the last selected method will appear on the display.
- In order to select the desired method press **METHOD** and a screen with the available methods will appear.
- Press ▲ ▼ keys to highlight the desired method. Press **Select**.

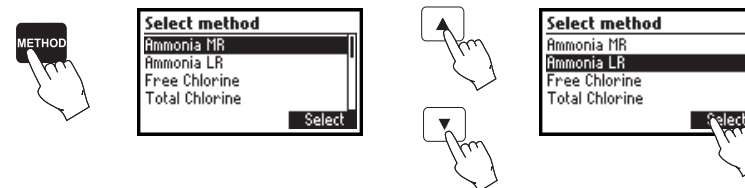

- After the desired method was selected, follow the measurement described in the related section.
- Before performing a test you should read all the instructions carefully.

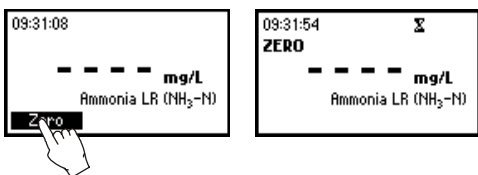

DATA MANAGEMENT

The instrument features a data log function to help you keep track of all your analysis. The data log can hold 200 individual measurements. Storing, viewing and deleting the data is possible using **LOG** and **RCL** keys.

Storing data: You can store only a valid measurement. Press **LOG** and the last valid measurement will be stored in a stack as a record with date and time stamps.

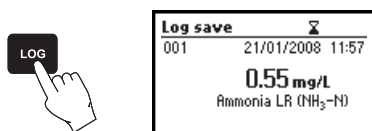

Viewing and deleting: You can view and delete the data log by pressing the **RCL** key. Deleting is based on the LIFO (last in, first out) scheme. Additionally, you can delete the data records all at once.

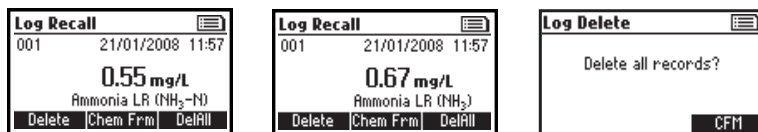

CHEMICAL FORM

Chemical form conversion factors are pre-programmed into the instrument and are method specific. In order to view the displayed result in the desired chemical form press the **▲** or **▼** to access to the second level of functions and then press the **Chem Frm** functional key to toggle between the existing chemical forms for the selected method.

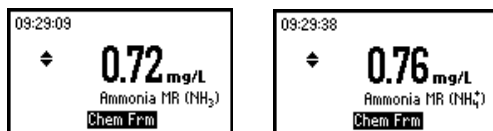

SETUP

In the Setup mode the instrument's parameters can be changed. Some parameters affect the measuring sequence and others are general parameters that change the behavior or appearance of the instrument.

Press **SETUP** to enter the setup mode.

Press **ESC** or **SETUP** to return to the main screen.

A list of setup parameters will be displayed with currently configured settings. Press **HELP** for additional information.

Press the **▲▼** keys to select the parameter and select a new value as follows:



Backlight

Values: 0 to 8.

Press **Modify** functional key to access the backlight value.

Use the **◀** functional keys or the **▲▼** keys to increase/decrease the value.

Press **Accept** functional key to confirm the value or **ESC** to return to the setup menu without saving the new value.

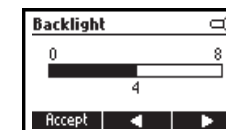
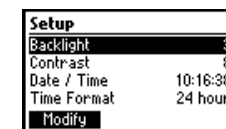

Contrast

Values: 0 to 20.

This option is used to set the display's contrast.

Press **Modify** functional key to change the display's contrast.

Use the **◀** functional keys or the **▲▼** keys to increase/decrease the value.

Press **Accept** functional key to confirm the value or **ESC** to return to the setup menu without saving the new value.

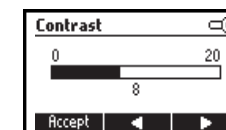

Date / Time

This option is used to set the instrument's date and time.

Press **Modify** functional key to change the date/time.

Press the **Left Arrow** functional key to highlight the value to be modified (year, month, day, hour, minute or second). Use the **Up/Down Arrow** keys to change the value.

Press **Accept** functional key to confirm or **ESC** to return to the setup menu without saving the new date/time.

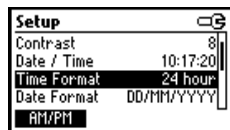
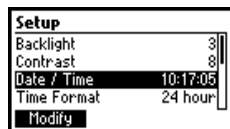

Time format

Option: AM/PM or 24 hour.

Press the functional key to select the desired time format.

Date format

Press **Modify** functional key to change the Date Format.

Use the **Up/Down Arrow** keys to select the desired format.

Press **Accept** functional key to confirm or **ESC** to return to the setup menu without saving the new format.

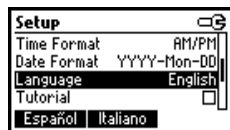
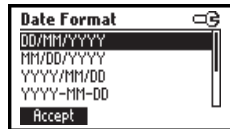
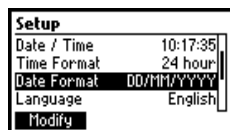

Language

Press the corresponding functional key to change the option.

If the new selected language cannot be loaded, the previously selected language will be reloaded.

Tutorial

Option: Enable or Disable.

If enabled this option will provide the user with guides, related to the current screen.

Press the functional key to enable/disable the tutorial mode.

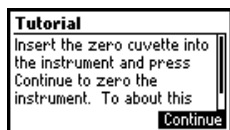
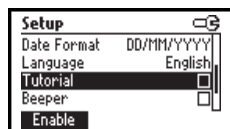

Beeper

Option: Enable or Disable.

When enabled, a short beep is heard every time a key is pressed.

Along with a beep, sounds when the pressed key is not active or an error condition is detected.

Press the functional key to enable/disable the beeper.

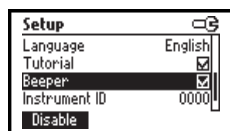

Instrument ID

Option: 0 to 9999.

This option is used to set the instrument's SID (identification number).

The instrument ID is used while loading data with a PC.

Press **Modify** functional key to access the instrument ID screen. Press the **Up/Down Arrow** keys in order to set the desired value.

Press **Accept** functional key to confirm the value or **ESC** to return to the setup menu without saving the new value.

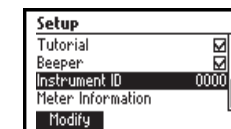

Meter information

Press **Select** functional key to view the instrument model, firmware version, language version and instrument serial number.

Press **ESC** to return to the Setup mode.

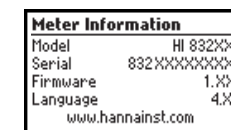
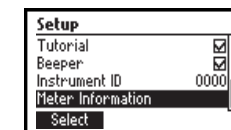

HELP MODE

HI 83203 offers an interactive contextual help mode that assists the user at any time.

To access help screens press **HELP**.

The instrument will display additional information related to the current screen. To read all available data, scroll the text using the **Up/Down Arrow** keys.

Press **Support** functional key to access a screen with Hanna service centers and their contact details.

Press **Accessories** functional key to access a page with instrument accessories.

To exit support or accessories screens press **ESC** and the instrument will return to the previous help screen.

To exit help mode just press **HELP** or **ESC** key again and the meter will display the last screen the user was in before entering help mode.

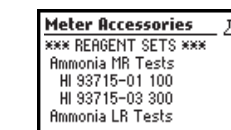
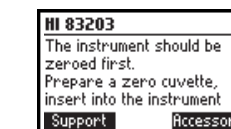

AMMONIA MEDIUM RANGE

SPECIFICATIONS

Range	0.00 to 10.00 mg/L
Resolution	0.01 mg/L
Accuracy	±0.05 mg/L ±5% of reading
Typical EMC Deviation	±0.01 mg/L
Light Source	Tungsten lamp with narrow band interference filter @ 420 nm
Method	Adaptation of the <i>ASTM Manual of Water and Environmental Technology, D1426-92</i> , Nessler method. The reaction between ammonia and reagents causes a yellow tint in the sample.

REQUIRED REAGENTS

Code	Description	Quantity
HI 93715A-0	First Reagent	4 drops (6 drops for seawater)
HI 93715B-0	Second Reagent	4 drops (10 drops for seawater)

REAGENT SETS

HI 93715-01 Reagents for 100 tests

HI 93715-03 Reagents for 300 tests

For other accessories see page 46.

MEASUREMENT PROCEDURE

- Select the *Ammonia MR* method using the procedure described in the *Method Selection* section (see page 11).
- Fill the cuvette with 10 mL of unreacted sample (up to the mark) and replace the cap.
- Place the cuvette into the holder and close the lid.
- Press ZERO key. The display will show “-0.0-” when the meter is zeroed and ready for measurement.

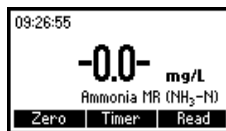
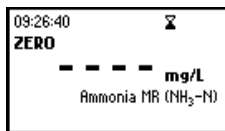
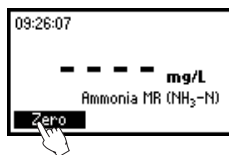
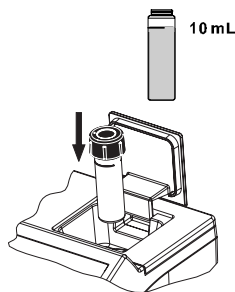

- Remove the cuvette.
- Add 4 drops of HI 93715A-0 First reagent (6 drops for seawater analysis). Replace the cap and mix the solution.
- Add 4 drops of HI 93715B-0 Second reagent (10 drops for seawater analysis). Replace the cap and mix the solution.
- Reinsert the cuvette into the instrument.

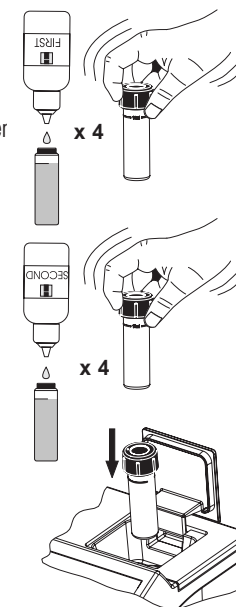

- Press TIMER and the display will show the countdown prior to the measurement or, alternatively, wait for 3 minutes and 30 seconds and press READ. When the timer ends the meter will perform the reading. The instrument displays the results in mg/L of ammonia nitrogen (NH₃-N).

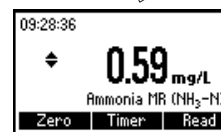
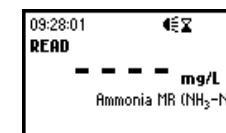
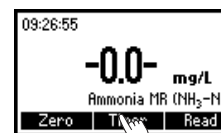

- Press the ▲ or ▼ to access the second level of functions.
- Press the Chem Frm functional key to convert the result in mg/L of ammonia (NH₃) and ammonium (NH₄⁺).

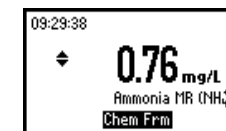
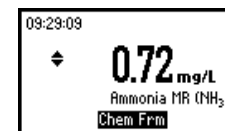
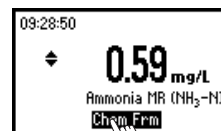

- Press the ▲ or ▼ to go back to the measurement screen.

INTERFERENCES

Interference may be caused by:

acetone, alcohols, aldehydes, glycine, hardness above 1 g/L, iron, organic chloramines, sulfide, various aliphatic and aromatic amines.

AMMONIA LOW RANGE

SPECIFICATIONS

Range	0.00 to 3.00 mg/L
Resolution	0.01 mg/L
Accuracy	±0.04 mg/L ±4% of reading
Typical EMC Deviation	±0.01 mg/L
Light Source	Tungsten lamp with narrow band interference filter @ 420 nm
Method	Adaptation of the <i>ASTM Manual of Water and Environmental Technology, D1426-92</i> , Nessler method. The reaction between ammonia and reagents causes a yellow tint in the sample.

REQUIRED REAGENTS

Code	Description	Quantity
HI 93700A-0	First Reagent	4 drops (6 drops for seawater)
HI 93700B-0	Second Reagent	4 drops (10 drops for seawater)

REAGENT SETS

HI 93700-01 Reagents for 100 tests

HI 93700-03 Reagents for 300 tests

For other accessories see page 46.

MEASUREMENT PROCEDURE

- Select the *Ammonia LR* method using the procedure described in the *Method Selection* section (see page 11).
- Fill the cuvette with 10 mL of unreacted sample (up to the mark) and replace the cap.
- Place the cuvette into the holder and close the lid.
- Press ZERO key. The display will show “-0.0-” when the meter is zeroed and ready for measurement.

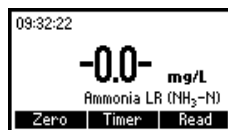
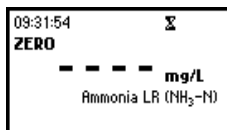
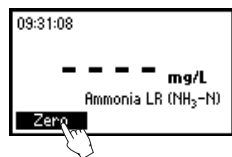
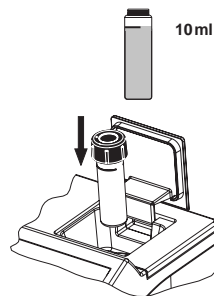

- Remove the cuvette.
- Add 4 drops of HI 93700A-0 First reagent (6 drops for seawater analysis). Replace the cap and mix the solution.
- Add 4 drops of HI 93700B-0 Second reagent (10 drops for seawater analysis). Replace the cap and mix the solution.
- Reinsert the cuvette into the instrument.
- Press TIMER and the display will show the countdown prior to the measurement or, alternatively, wait for 3 minutes and 30 seconds and press READ. When the timer ends the meter will perform the reading. The instrument displays the results in mg/L of ammonia nitrogen (NH₃-N).

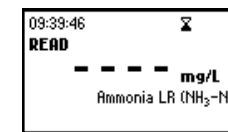
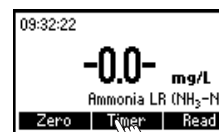
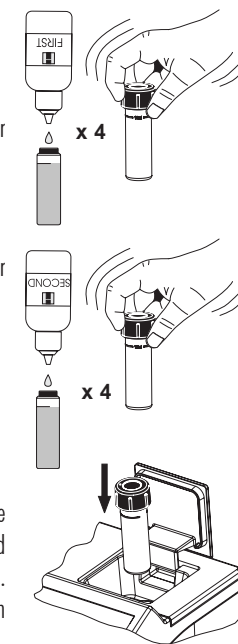

- Press the ▲ or ▼ to access the second level of functions.
- Press the Chem Frm functional key to convert the result in mg/L of ammonia (NH₃) and ammonium (NH₄⁺).

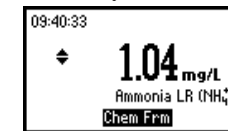
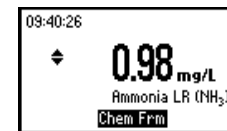
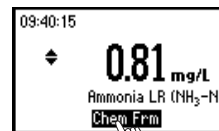

- Press the ▲ or ▼ to go back to the measurement screen.

INTERFERENCES

Interference may be caused by: acetone, alcohols, aldehydes, glycine, hardness above 1 g/L, iron, organic chloramines, sulfide, various aliphatic and aromatic amines.

FREE CHLORINE

SPECIFICATIONS

Range	0.00 to 2.50 mg/L
Resolution	0.01 mg/L
Accuracy	±0.03 mg/L ±3% of reading
Typical EMC Deviation	±0.01 mg/L
Light Source	Tungsten lamp with narrow band interference filter @ 525 nm
Method	Adaptation of the <i>EPA DPD method 330.5</i> . The reaction between free chlorine and the DPD reagent causes a pink tint in the sample.

REQUIRED REAGENTS

POWDER:

Code	Description	Quantity
HI 93701-0	DPD	1 packet

LIQUID:

Code	Description	Quantity
HI 93701A-F	DPD1 Indicator	3 drops
HI 93701B-F	DPD1 Buffer	3 drops

REAGENT SETS

- HI 93701-F Reagents for 300 tests (liquid)
 - HI 93701-01 Reagents for 100 tests (powder)
 - HI 93701-03 Reagents for 300 tests (powder)
- For other accessories see page 46.

MEASUREMENT PROCEDURE

- Select the *Free Chlorine* method using the procedure described in the *Method Selection* section (see page 11).

- Fill the cuvette with 10 mL of unreacted sample (up to the mark) and replace the cap.
- Place the cuvette into the holder and close the lid.

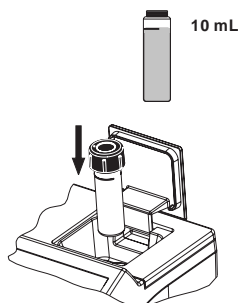

- Press ZERO key. The meter will show “-0.0-” when the meter is zeroed and ready for measurement.



- Remove the cuvette.

Powder reagents procedure

- Add the content of one packet of HI 93701-0 DPD reagent. Replace the cap and shake gently for 20 seconds (or 2 minutes for seawater analysis).

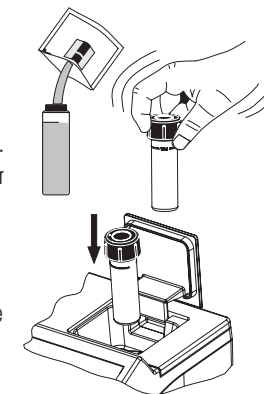

- Wait for a minute to allow the undissolved reagent to precipitate and reinsert the cuvette into the instrument.

- Press TIMER and the display will show the countdown prior to the measurement or, alternatively, wait for 1 minute and press READ. When the timer ends the meter will perform the reading. The instrument displays the results in mg/L of free chlorine.

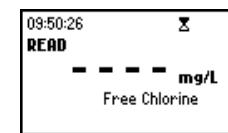
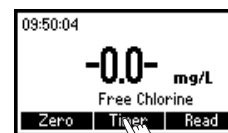

Liquid reagents procedure

- To an empty cuvette add 3 drops of HI 93701A-F DPD1 indicator and 3 drops of HI 93701B-F DPD1 buffer. Swirl gently to mix, and immediately add 10 mL of unreacted sample. Replace the cap and shake gently again.

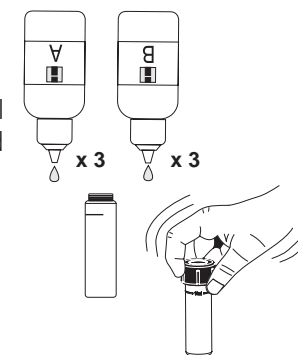

- Reinsert the cuvette into the instrument.

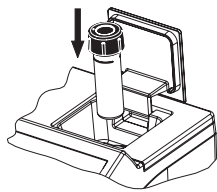

- Press **TIMER** and the display will show the countdown prior to the measurement or, alternatively, wait for 1 minute and press **READ**. When the timer ends the meter will perform the reading.

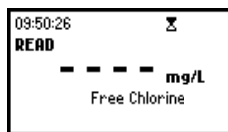

- The instrument displays the results in mg/L of free chlorine.



INTERFERENCES

Interference may be caused by: Bromine, Iodine, Ozone, Oxidized forms of Chromium and Manganese.

In case of water with hardness greater than 500 mg/L CaCO₃, shake the sample for approximately 2 minutes after adding the powder reagent.

In case of water with alkalinity greater than 250 mg/L CaCO₃ or acidity greater than 150 mg/L CaCO₃, the color of the sample may develop only partially, or may rapidly fade. To resolve this, neutralize the sample with diluted HCl or NaOH.

TOTAL CHLORINE

SPECIFICATIONS

Range	0.00 to 3.50 mg/L
Resolution	0.01 mg/L
Accuracy	±0.03 mg/L ±3% of reading
Typical EMC Deviation	±0.01 mg/L
Light Source	Tungsten lamp with narrow band interference filter @ 525 nm
Method	Adaptation of the <i>EPA DPD method 330.5</i> . The reaction between the chlorine and the DPD reagent causes a pink tint in the sample.

REQUIRED REAGENTS

POWDER:

Code	Description	Quantity
HI 93711-0	DPD	1 packet

LIQUID:

Code	Description	Quantity
HI 93701A-T	DPD1 indicator	3 drops
HI 93701B-T	DPD1 buffer	3 drops
HI 93701C	DPD3 solution	1 drop

REAGENT SETS

- HI 93701-T Reagents for 300 total chlorine tests (liquid)
- HI 93711-01 Reagents for 100 total chlorine tests (powder)
- HI 93711-03 Reagents for 300 total chlorine tests (powder)

For other accessories see page 46.

MEASUREMENT PROCEDURE

- Select the *Total Chlorine* method using the procedure described in the *Method Selection* section (see page 11).
- Fill the cuvette with 10 mL of unreacted sample (up to the mark) and replace the cap.
- Place the cuvette into the holder and close the lid.

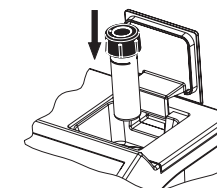

- Press ZERO key. The meter will show “-0.0-” when the meter is zeroed and ready for measurement.

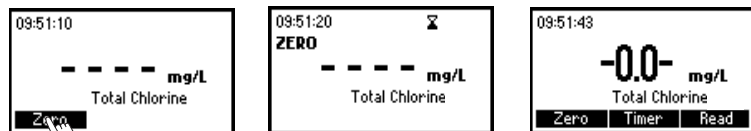

- Remove the cuvette.

Powder reagents procedure

- Add 1 packet of HI 93711-0 DPD reagent. Replace the cap and shake gently for 20 seconds (or 2 minutes for seawater analysis).
- Reinsert the cuvette into the instrument.
- Press TIMER and the display will show the countdown prior to the measurement or, alternatively, wait for 2 minutes and 30 seconds and press READ. When the timer ends the meter will perform the reading. The instrument displays the results in mg/L of total chlorine.

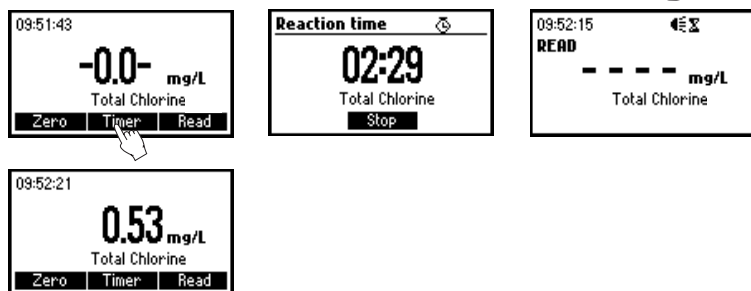
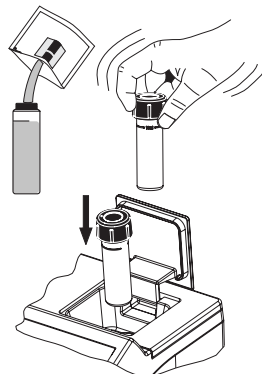

Liquid reagents procedure

- To an empty cuvette add 3 drops of HI 93701A-T DPD1 indicator, 3 drops of HI 93701B-T DPD1 buffer and 1 drop of HI 93701C DPD3 solution. Swirl gently to mix and immediately add 10 mL of unreacted sample. Replace the cap and shake gently again.

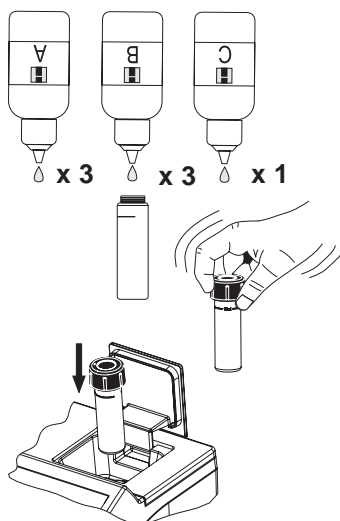

- Reinsert the cuvette into the instrument.

- Press TIMER and the display will show the countdown prior to the measurement or, alternatively, wait for 2 minutes and 30 seconds and press READ. When the timer ends the meter will perform the reading.

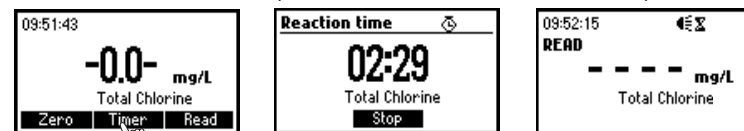

- The instrument displays the results in mg/L of total chlorine.



Note: free and total chlorine have to be measured separately with fresh unreacted samples following the related procedure if both values are requested.

INTERFERENCES

Interference may be caused by: Bromine, Iodine, Ozone, Oxidized forms of Chromium and Manganese.

In case of water with hardness greater than 500 mg/L CaCO₃, shake the sample for approximately 2 minutes after adding the powder reagent.

In case of water with alkalinity greater than 250 mg/L CaCO₃ or acidity greater than 150 mg/L CaCO₃, the color of the sample may develop only partially, or may rapidly fade. To resolve this, neutralize the sample with diluted HCl or NaOH.

COPPER HIGH RANGE

SPECIFICATIONS

Range	0.00 to 5.00 mg/L
Resolution	0.01 mg/L
Accuracy	±0.02 mg/L ±4% of reading
Typical EMC Deviation	±0.01 mg/L
Light Source	Tungsten lamp with narrow band interference filter @ 575 nm
Method	Adaptation of the <i>EPA method</i> . The reaction between copper and the bicinchoninate reagent causes a purple tint in the sample.

REQUIRED REAGENTS

Code	Description	Quantity
HI 93702-0	Bicinchoninate	1 packet

REAGENT SETS

HI 93702-01 Reagents for 100 tests

HI 93702-03 Reagents for 300 tests

For other accessories see page 46.

MEASUREMENT PROCEDURE

- Select the *Copper HR* method using the procedure described in the *Method Selection* section (see page 11).

- Fill the cuvette with 10 mL of unreacted sample (up to the mark) and replace the cap.

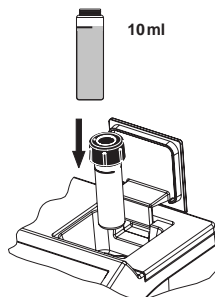

- Place the cuvette into the holder and close the lid.

- Press ZERO key. The meter will show “-0.0-” when the meter is zeroed and ready for measurement.

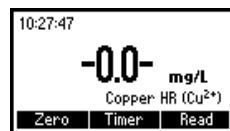
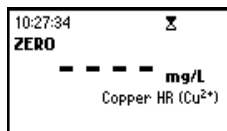
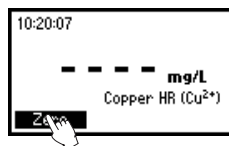

- Remove the cuvette.
- Add the content of one packet of HI 93702-0 Bicinchoninate. Replace the cap and shake gently for about 15 seconds.
- Reinsert the cuvette into the instrument.

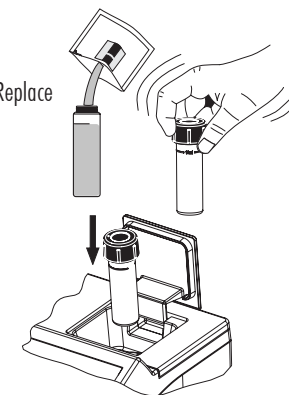

- Press TIMER and the display will show the countdown prior to the measurement or, alternatively, wait for 45 seconds and press READ. When the timer ends the meter will perform the reading.

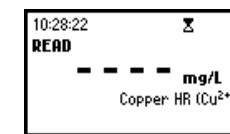
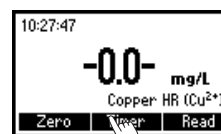

- The instrument displays the results in mg/L of copper.



INTERFERENCES

Interference may be caused by:

Silver
Cyanide

For samples overcoming buffering capacity of reagent (around pH 6.8), pH should be adjusted between 6 and 8.

COPPER LOW RANGE

SPECIFICATIONS

Range	0 to 1000 µg/L
Resolution	1 µg/L
Accuracy	±10 µg/L ±5% of reading
Typical EMC Deviation	±1 µg/L
Light Source	Tungsten lamp with narrow band interference filter @ 575 nm
Method	Adaptation of the <i>EPA method</i> . The reaction between copper and the bicinchoninate reagent causes a purple tint in the sample.

REQUIRED REAGENTS

Code	Description	Quantity
HI 93747-0	Bicinchoninate	1 packet

REAGENT SETS

HI 93747-01 Reagents for 100 tests

HI 93747-03 Reagents for 300 tests

For other accessories see page 46.

MEASUREMENT PROCEDURE

- Select the *Copper LR* method using the procedure described in the *Method Selection* section (see page 11).
- Fill the cuvette with 10 mL of unreacted sample (up to the mark) and replace the cap.
- Place the cuvette into the holder and close the lid.
- Press ZERO key. The meter will show “-0.0-” when the meter is zeroed and ready for measurement.

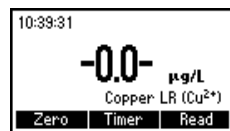
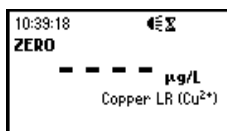
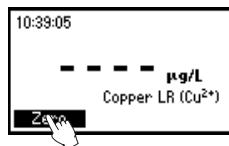
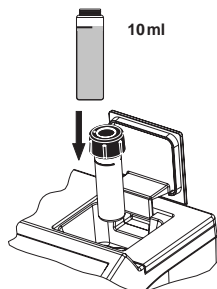

- Remove the cuvette.
- Add the content of one packet of HI 93747-0 Bicinchoninate. Replace the cap and shake gently for about 15 seconds.
- Reinsert the cuvette into the instrument.
- Press TIMER and the display will show the countdown prior to the measurement or, alternatively, wait for 45 seconds and press READ. When the timer ends the meter will perform the reading.

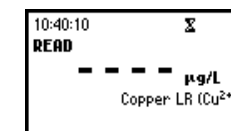
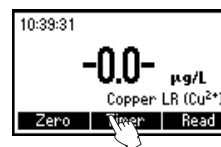
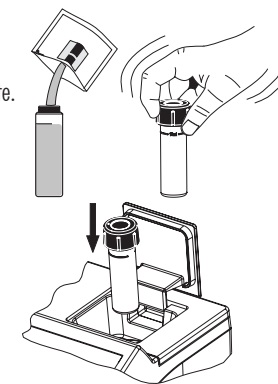

- The instrument displays the results in mg/L of copper.

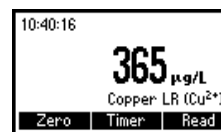

INTERFERENCES

Interference may be caused by:

Silver
Cyanide

For samples overcoming buffering capacity of reagent (around pH 6.8), pH should be adjusted between 6 and 8.

NITRATE

SPECIFICATIONS

Range	0.0 to 30.0 mg/L
Resolution	0.1 mg/L
Accuracy	±0.5 mg/L ±10% of reading
Typical EMC Deviation	±0.1 mg/L
Light Source	Tungsten lamp with narrow band interference filter @ 525 nm
Method	Adaptation of the cadmium reduction method. The reaction between nitrate and the reagent causes an amber tint in the sample.

REQUIRED REAGENTS

Code	Description	Quantity
HI 93728-0	Powder reagent	1 packet

REAGENT SETS

HI 93728-01 Reagents for 100 tests

HI 93728-03 Reagents for 300 tests

For other accessories see page 46.

MEASUREMENT PROCEDURE

- Select the *Nitrate* method using the procedure described in the *Method Selection* section (see page 11).
- Using the pipette, fill the cuvette with 6 ml of sample, up to half of its height, and replace the cap.

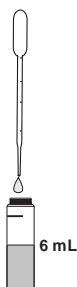

- Place the cuvette into the holder and close the lid.
- Press ZERO key. The display will show “-0.0-” when the meter is zeroed and ready for measurement.

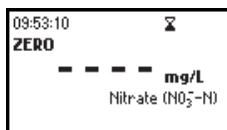
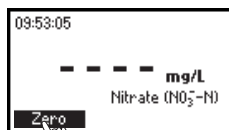
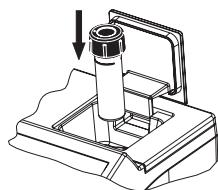

- Remove the cuvette and add the content of one packet of HI 93728-0 reagent.



- Replace the cap and immediately shake vigorously up and down for exactly 10 seconds. Continue to mix by inverting the cuvette gently for 50 seconds, while taking care not to induce air bubbles. Powder will not completely dissolve. Time and way of shaking could sensitively affect the measurement.
- Reinsert the cuvette into the instrument, taking care not to shake it.
- Press TIMER and the display will show the countdown prior to the measurement or, alternatively, wait for 4 minutes and 30 seconds and press READ. When the timer ends the meter will perform the reading. The instrument displays the results in mg/L of nitrate-nitrogen.

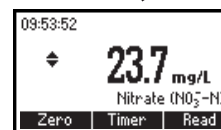
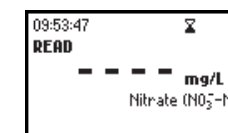
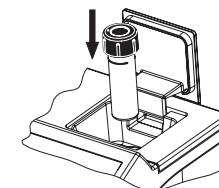
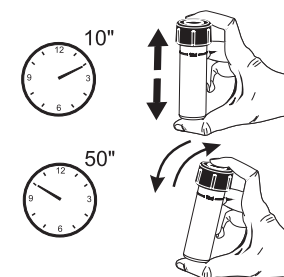

- Press the ▲ or ▼ to access the second level of functions.
- Press the Chem Frm functional key to convert the result in mg/L of nitrate (NO₃⁻).

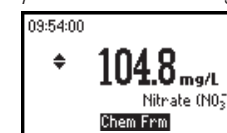
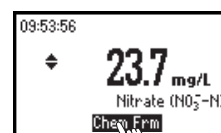

- Press the ▲ or ▼ to go back to the measurement screen.

INTERFERENCES

Interference may be caused by:

- Ammonia and amines, as urea and primary aliphatic amines
- Chloride above 100 ppm
- Chlorine above 2 ppm
- Copper
- Iron(III)
- Strong oxidizing and reducing substances
- Sulfide must be absent

NITRITE HIGH RANGE

SPECIFICATIONS

Range	0 to 150 mg/L
Resolution	1 mg/L
Accuracy	±4 mg/L ±4% of reading
Typical EMC	±1 mg/L
Deviation	
Light Source	Tungsten lamp with narrow band interference filter @ 575 nm
Method	Adaptation of the Ferrous Sulfate method. The reaction between nitrite and the reagent causes a greenish-brown tint in the sample.

REQUIRED REAGENTS

Code	Description	Quantity
HI 93708-0	Powder reagent	1 packet

REAGENT SETS

HI 93708-01 Reagents for 100 tests

HI 93708-03 Reagents for 300 tests

For other accessories see page 46.

MEASUREMENT PROCEDURE

- Select the *Nitrite HR* method using the procedure described in the *Method Selection* section (see page 11).

- Fill the cuvette up to the mark with 10 mL of unreacted sample and replace the cap.

- Place the cuvette into the holder and close the lid.
- Press ZERO key. The display will show “-0.0-” when the meter is zeroed and ready for measurement.

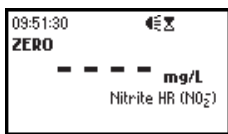
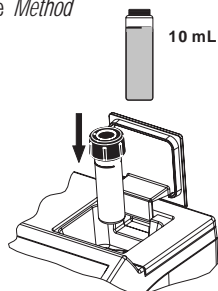

- Remove the cuvette.
- Add the content of one packet of HI 93708-0 reagent. Replace the cap and shake gently until completely dissolved.

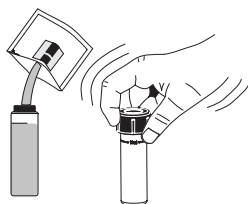

- Reinsert the cuvette into the instrument.

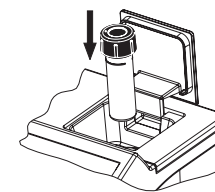

- Press TIMER and the display will show the countdown prior to the measurement or, alternatively, wait for 10 minutes and press READ. When the timer ends the meter will perform the reading. The instrument displays concentration in mg/L of nitrite.

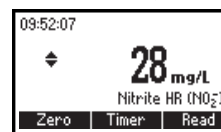
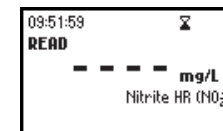

- Press the ▲ or ▼ to access the second level of functions.
- Press the Chem Frm functional key to convert the result in mg/L of nitrogen-nitrite (NO₂-N) and sodium nitrite (NaNO₂).

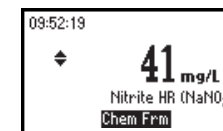
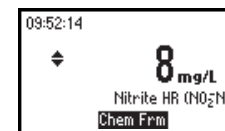

- Press the ▲ or ▼ to go back to the measurement screen.

NITRITE LOW RANGE

SPECIFICATIONS

Range	0.00 to 0.35 mg/L
Resolution	0.01 mg/L
Accuracy	±0.02 mg/L ±4% of reading
Typical EMC	±0.01 mg/L
Deviation	
Light Source	Tungsten lamp with narrow band interference filter @ 525 nm
Method	Adaptation of the <i>EPA Diazotization method 354.1</i> . The reaction between nitrite and the reagent causes a pink tint in the sample.

REQUIRED REAGENTS

Code	Description	Quantity
HI 93707-0	Powder reagent	1 packet

REAGENT SETS

HI 93707-01 Reagents for 100 tests

HI 93707-03 Reagents for 300 tests

For other accessories see page 46.

MEASUREMENT PROCEDURE

- Select the *Nitrite LR* method using the procedure described in the *Method Selection* section (see page 11).

- Fill the cuvette up to the mark with 10 mL of unreacted sample (up to the mark) and replace the cap.

- Place the cuvette into the holder and close the lid.
- Press ZERO key. The display will show “-0.0-” when the meter is zeroed and ready for measurement.

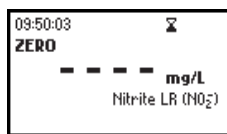
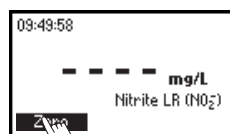
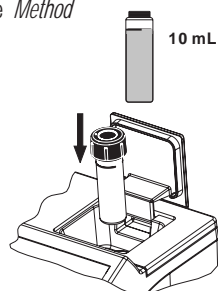

- Remove the cuvette.
- Add the content of one packet of HI 93707-0 reagent. Replace the cap and shake gently for about 15 seconds.

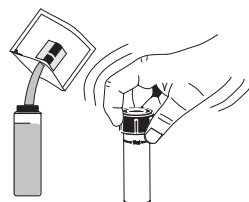

- Reinsert the cuvette into the instrument.

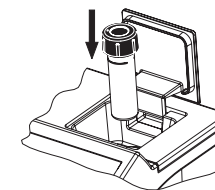

- Press TIMER and the display will show the countdown prior to the measurement or, alternatively, wait for 6 minutes and press READ. When the timer ends the meter will perform the reading. The instrument displays concentration in mg/L of nitrite.

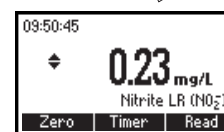
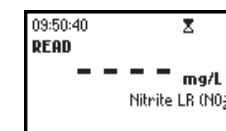

- Press the ▲ or ▼ to access the second level of functions.
- Press the Chem Frm functional key to convert the result in mg/L of nitrogen-nitrite (NO₂-N) and sodium nitrite (NaNO₂).

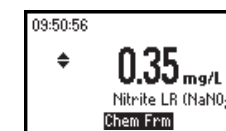
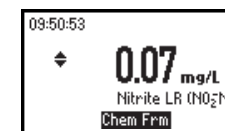
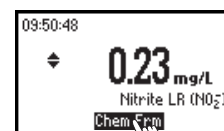

- Press the ▲ or ▼ to go back to the measurement screen.

INTERFERENCES

Interference may be caused by the following ions:

ferrous, ferric, cupric, mercurous, silver, antimonious, bismuth, auric, lead, metavanadate and chloroplatinate. Strongly reducing and oxidizing reagents.

High levels of nitrate (above 100 mg/L) could yield falsely high readings due to a minute amount of reduction to nitrite that could occur at these levels.

DISSOLVED OXYGEN

SPECIFICATIONS

Range	0.0 to 10.0 mg/L
Resolution	0.1 mg/L
Accuracy	±0.4 mg/L ±3% of reading
Typical EMC Deviation	± 0.1 mg/L
Light Source	Tungsten lamp with narrow band interference filter @ 420 nm
Method	Adaptation of the <i>Standard Methods for the Examination of Water and Wastewater, 18th edition</i> , Azide modified Winkler method. The reaction between dissolved oxygen and the reagents causes a yellow tint in the sample.

REQUIRED REAGENTS

Code	Description	Quantity
HI 93732A-0	Reagent A	5 drops
HI 93732B-0	Reagent B	5 drops
HI 93732C-0	Reagent C	10 drops

REAGENT SET

HI 93732-01 Reagents for 100 tests

HI 93732-03 Reagents for 300 tests

For other accessories see page 46.

MEASUREMENT PROCEDURE

- Select the *Dissolved Oxygen* method using the procedure described in the *Method Selection* section (see page 11).

- Fill one 60 mL glass bottle completely with the unreacted sample.
- Replace the cap and ensure that a small part of the sample spills over.

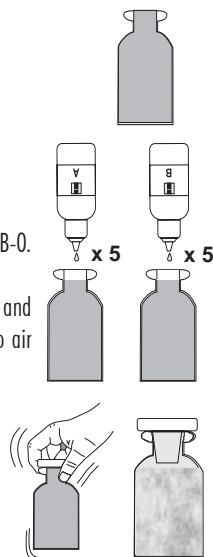

- Remove the cap and add 5 drops of HI 93732A-0 and 5 drops of HI 93732B-0.
- Add more sample, to fill the bottle completely. Replace the cap again and ensure that a part of the sample spills over. This is to make sure that no air bubbles have been trapped inside, which could alter the reading.

- Invert several times the bottle. The sample becomes orange-yellow and a flocculent agent will appear.

- Let the sample stand and the flocculent agent will start to settle.

- After approximately 2 minutes, when the upper half of the bottle becomes limpid, add 10 drops of HI 93732C-0.

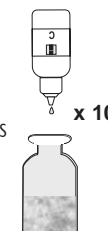

- Replace the cap and invert the bottle until the settled flocculent dissolves completely. The sample is ready for measurement when it is yellow and completely limpid.

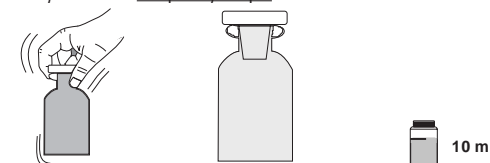

- Fill the cuvette up to the mark with 10 mL of the unreacted (original) sample, and replace the cap. This is the blank.



- Place the cuvette into the holder and close the lid.

- Press ZERO key. The display will show “-0.0-” when the meter is zeroed and ready for measurement.

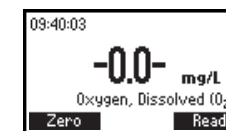
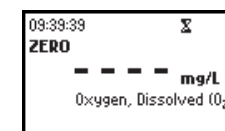
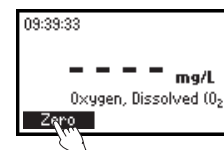
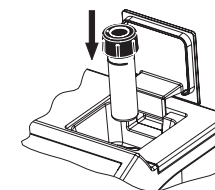

- Remove the cuvette.

- Fill another cuvette up to the mark with 10 mL of the reacted sample and replace the cap.



- Reinsert the cuvette into the instrument.

- Press READ to start the reading. The instrument will display the results in mg/L of dissolved oxygen.

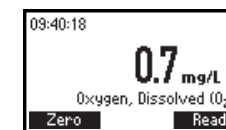
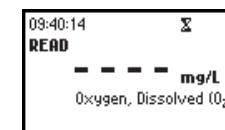
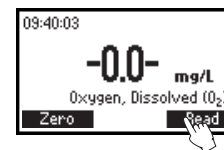

INTERFERENCES

Interferences may be caused by reducing and oxidizing materials.

pH

SPECIFICATIONS

Range	6.5 to 8.5 pH
Resolution	0.1 pH
Accuracy	±0.1 pH
Typical EMC Deviation	±0.1 pH
Light Source	Tungsten lamp with narrow band interference filter @ 525 nm
Method	Adaptation of the Phenol Red method. The reaction with the reagent causes a yellow to red tint in the sample.

REQUIRED REAGENTS

Code	Description	Quantity
HI 93710-0	Phenol Red Indicator	5 drops

REAGENT SETS

HI 93710-01 Reagents for 100 pH tests

HI 93710-03 Reagents for 300 pH tests

For other accessories see page 46.

MEASUREMENT PROCEDURE

- Select the *pH* method using the procedure described in the *Method Selection* section (see page 11).
- Fill the cuvette with 10 mL of unreacted sample (up to the mark) and replace the cap.
- Place the cuvette into the holder and close the lid.
- Press ZERO key. The display will show “-0.0-” when the meter is zeroed and ready for measurement.

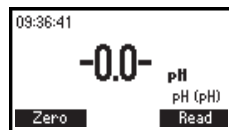
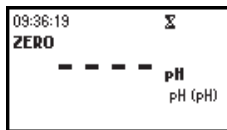
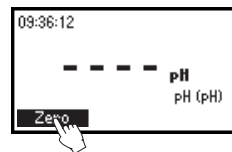
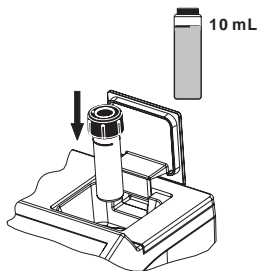

- Remove the cuvette and add 5 drops of HI 93710-0 Phenol Red Indicator. Replace the cap and mix the solution.

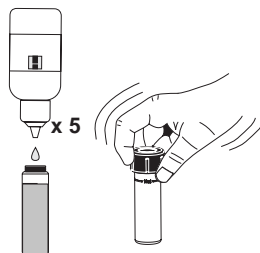

- Reinsert the cuvette into the instrument.

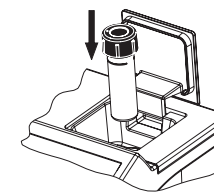

- Press the READ key to start the reading. The instrument displays the pH value.

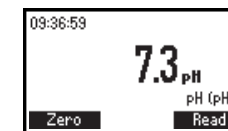
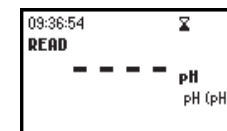
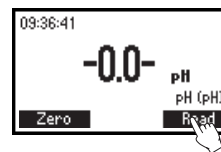

PHOSPHATE HIGH RANGE

SPECIFICATIONS

Range	0.0 to 30.0 mg/L
Resolution	0.1 mg/L
Accuracy	±1 mg/L ±4% of reading
Typical EMC Dev.	±0.1 mg/L
Light Source	Tungsten lamp with narrow band interference filter @ 525 nm
Method	Adaptation of the <i>Standard Methods for the Examination of Water and Wastewater, 18th edition</i> , Amino Acid method. The reaction between phosphate and reagents causes a blue tint in the sample.

REQUIRED REAGENTS

Code	Description	Quantity
HI 93717A-0	Molybdate	10 drops
HI 93717B-0	Reagent B	1 packet

REAGENT SETS

HI 93717-01 Reagents for 100 tests

HI 93717-03 Reagents for 300 tests

For other accessories see page 46.

MEASUREMENT PROCEDURE

- Select the *Phosphate HR* method using the procedure described in the *Method Selection* section (see page 11).

- Fill the cuvette with 10 mL of unreacted sample (up to the mark) and replace the cap.



- Place the cuvette into the holder and close the lid.

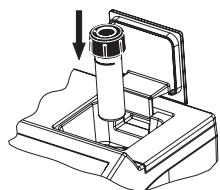

- Press ZERO key. The display will show “-0.0-” when the meter is zeroed and ready for measurement.

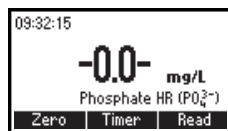
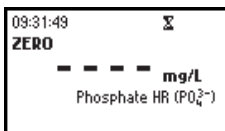
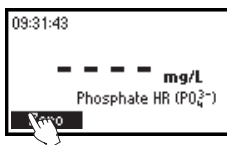

- Remove the cuvette.
- Add 10 drops of HI 93717A-0 Molybdate reagent.

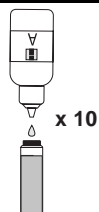

- Add the content of one packet of HI 93717B-0 Phosphate HR Reagent B to the cuvette. Replace the cap and shake gently until completely dissolved.

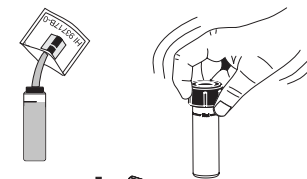

- Reinsert the cuvette into the instrument.

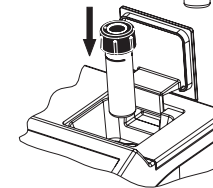

- Press TIMER and the display will show the countdown prior to the measurement or, alternatively, wait for 5 minutes and press READ. When the timer ends the meter will perform the reading. The instrument displays the results in mg/L of phosphate (PO_4^{3-}).

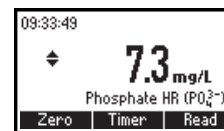
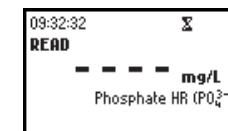
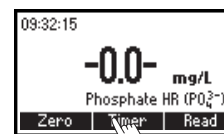

- Press the ▲ or ▼ to access the second level of functions.
- Press the Chem Frm functional key to convert the result in mg/L of phosphorus (P) and phosphorus pentoxide (P_2O_5).

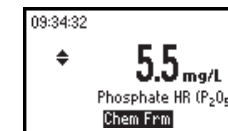
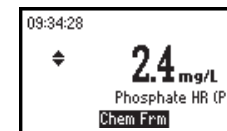
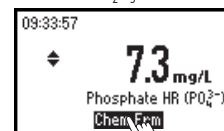

- Press the ▲ or ▼ to go back to the measurement screen.

INTERFERENCES

Sulfide

Chloride above 150000 mg/L)

Calcium above 10000 mg/L as $CaCO_3$

Magnesium above 40000 mg/L as $CaCO_3$

Ferrous iron above 100 mg/L

PHOSPHATE LOW RANGE

SPECIFICATIONS

Range	0.00 to 2.50 mg/L
Resolution	0.01 mg/L
Accuracy	±0.04 mg/L ±4% of reading
Typical EMC Dev.	±0.01 mg/L
Light Source	Tungsten lamp with narrow band interference filter @ 610 nm
Method	Adaptation of the Ascorbic Acid method. The reaction between phosphate and the reagent causes a blue tint in the sample.

REQUIRED REAGENTS

Code	Description	Quantity
HI 93713-0	Powder reagent	1 packet

REAGENT SETS

HI 93713-01 Reagents for 100 tests

HI 93713-03 Reagents for 300 tests

For other accessories see page 46.

MEASUREMENT PROCEDURE

- Select the *Phosphate LR* method using the procedure described in the *Method Selection* section (see page 11).

- Rinse, cap and shake the cuvette several times with unreacted sample. Fill the cuvette with 10 mL of sample up to the mark and replace the cap.

- Place the cuvette into the holder and close the lid.

- Press ZERO key. The display will show “-0.0-” when the meter is zeroed and ready for measurement.

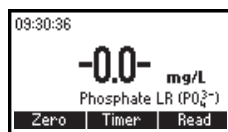
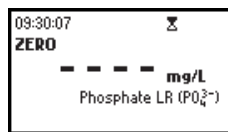
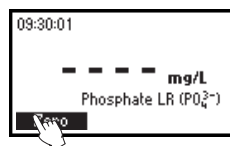
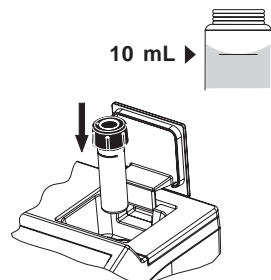

- Remove the cuvette and add the content of one packet of HI 93713-0 reagent. Replace the cap and shake gently (for about 2 minutes) until the powder is completely dissolved.

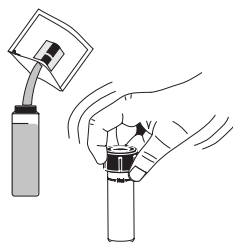

- Reinsert the cuvette into the instrument.
- Press TIMER and the display will show the countdown prior to the measurement or, alternatively, wait for 3 minutes and press READ. When the timer ends the meter will perform the reading. The instrument displays concentration in mg/L of phosphate (PO_4^{3-}).

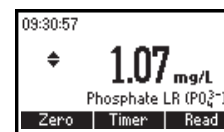
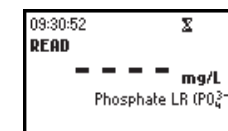
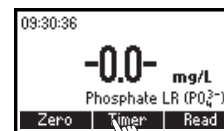
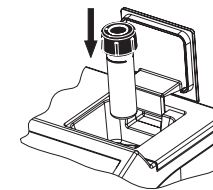

- Press the ▲ or ▼ to access the second level of functions.
- Press the Chem Frm functional key to convert the result in mg/L of phosphorus (P) and phosphorus pentoxide (P_2O_5).

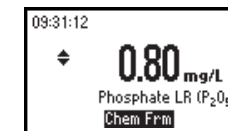
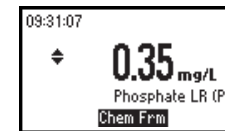
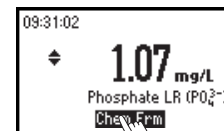

- Press the ▲ or ▼ to go back to the measurement screen.

INTERFERENCES

Interference may be caused by:

Iron above 50 mg/L

Silica above 50 mg/L

Silicate above 10 mg/L

Copper above 10 mg/L

Hydrogen sulfide, arsenate, turbid sample and highly buffered samples also interfere.

ERRORS AND WARNINGS

The instrument shows clear warning messages when erroneous conditions appear and when measured values are outside the expected range. These messages are described below.



No Light: The light source is not functioning properly.



Light Leak: There is an excess amount of ambient light reaching the detector.



Inverted cuvettes: The sample and the zero cuvettes are inverted.



Battery Low: The battery capacity is lower than 10%.



Light Low: The instrument cannot adjust the light level. Please check that the sample does not contain any debris.



Light High: There is too much light to perform a measurement. Please check the preparation of the zero cuvette.

DATA MANAGEMENT

The analyzed data can be managed using Hanna's product HI 92000, Windows® Compatible Software.

	Date	Time	Conc.	Unit	Parameter	Absorbance	Instr. ID.	Instr. Serial No.
1	2007/06/19	10.04.12	0.95	mg/L	Free chlorine	0.4915167	0007	83414201XAG
2	2007/06/19	10.04.43	0.95	mg/L	Free chlorine	0.4919497	0007	83414201XAG
3	2007/06/19	10.05.03	0.96	mg/L	Free chlorine	0.4924213	0007	83414201XAG
4								
5								
6								
7								
8								
9								
10								
11								
12								
13								
14								
15								
16								
17								

Method
 ssler
 ssler
 D
 D
 inchoninate
 inchoninate
 mium Reduction
 rous Sulfate
 izotization
 rklr
 enol Red
 ino Acid
 ascorbic Acid

ACCESSORIES

REAGENT SETS

HI 93700-01	100 ammonia LR tests
HI 93700-03	300 ammonia LR tests
HI 93701-01	100 free chlorine tests (powder)
HI 93701-03	300 free chlorine tests (powder)
HI 93701-F	300 free chlorine tests (liquid)
HI 93701-T	300 total chlorine tests (liquid)
HI 93702-01	100 copper HR tests
HI 93702-03	300 copper HR tests
HI 93707-01	100 nitrite LR tests
HI 93707-03	300 nitrite LR tests
HI 93708-01	100 nitrite HR tests
HI 93708-03	300 nitrite HR tests
HI 93710-01	100 pH tests
HI 93710-03	300 pH tests
HI 93711-01	100 total chlorine tests (powder)
HI 93711-03	300 total chlorine tests (powder)
HI 93713-01	100 phosphate LR tests
HI 93713-03	300 phosphate LR tests
HI 93715-01	100 ammonia MR tests
HI 93715-03	300 ammonia MR tests
HI 93717-01	100 phosphate HR tests
HI 93717-03	300 phosphate HR tests
HI 93728-01	100 nitrate tests
HI 93728-03	300 nitrate tests
HI 93732-01	100 dissolved oxygen tests
HI 93732-03	300 dissolved oxygen tests
HI 93747-01	100 copper LR tests
HI 93747-03	300 copper LR tests

OTHER ACCESSORIES

HI 731318	Cloth for wiping cuvettes (4 pcs)
HI 731321	glass cuvettes (4 pcs)
HI 731325W	new cap for cuvette (4 pcs)
HI 740034	cap for 100 mL beaker (6 pcs)
HI 740036	100 mL plastic beaker (6 pcs)
HI 740038	60 mL glass bottle and stopper
HI 740142	1 mL graduated syringe
HI 740143	1 mL graduated syringe (6 pcs)
HI 740144	pipette tip (6 pcs)
HI 740157	plastic refilling pipette (20 pcs)
HI 740220	25 mL glass cylinders with caps (2 pcs)
HI 740226	5 mL graduated syringe
HI 92000	Windows Compatible Software
HI 920013	PC connection cable
HI 93703-50	cuvette cleaning solution (230 mL)

WARRANTY

All Hanna Instruments meters are warranted for two years against defects in workmanship and materials when used for its intended purpose and maintained according to the instructions.

This warranty is limited to repair or replacement free of charge.

Damages due to accident, misuse, tampering or lack of prescribed maintenance are not covered.

If service is required, contact your dealer. If under warranty, report the model number, date of purchase, serial number and the nature of the failure. If the repair is not covered by the warranty, you will be notified of the charges incurred.

If the instrument is to be returned to Hanna Instruments, first obtain a Returned Goods Authorization Number from the Customer Service Department and then send it with shipment costs prepaid. When shipping any instrument, make sure it is properly packaged for complete protection.

To validate your warranty, fill out and return the enclosed warranty card within 14 days from the date of purchase.

Recommendations for Users

Before using these products, make sure that they are entirely suitable for your specific application and for the environment in which they are used.

Operation of these instruments may cause unacceptable interferences to other electronic equipments, this requiring the operator to take all necessary steps to correct interferences.

Any variation introduced by the user to the supplied equipment may degrade the instruments' EMC performance.

To avoid damages or burns, do not put the instrument in microwave ovens. For yours and the instrument safety do not use or store the instrument in hazardous environments.

Hanna Instruments reserves the right to modify the design, construction and appearance of its products without advance notice.

HANNA LITERATURE

Hanna publishes a wide range of catalogs and handbooks for an equally wide range of applications. The reference literature currently covers areas such as:

- Water Treatment
- Process
- Swimming Pools
- Agriculture
- Food
- Laboratory

and many others. New reference material is constantly being added to the library.

For these and other catalogs, handbooks and leaflets contact your dealer or the Hanna Customer Service Center nearest to you. To find the Hanna Office in your vicinity, check our home page at www.hannainst.com.

SALES AND TECHNICAL SERVICE CONTACTS

Australia:

Tel. (03) 9769.0666 • Fax (03) 9769.0699
e-mail: hannains@hannainst.com.au

China:

Tel. (10) 88570068 • Fax (10) 88570060
e-mail: hannachina@vip.sina.com

Egypt:

Tel. & Fax (02) 2758.683
e-mail: hannaegypt@go.com.eg

Germany:

Tel. (07851) 9129-0 • Fax (07851) 9129-99
e-mail: hannager@aol.com

Greece:

Tel. (210) 823.5192 • Fax (210) 884.0210
e-mail: hannagr@otenet.gr

Indonesia:

Tel. (21) 4584.2941 • Fax (21) 4584.2942
e-mail: transit@dnnet.net.id

Japan:

Tel. (03) 3258.9565 • Fax (03) 3258.9567
e-mail: sales@hanna.co.jp

Korea:

Tel. (02) 2278.5147 • Fax (02) 2264.1729
e-mail: mccoynhan@chollian.net

Malaysia:

Tel. (603) 5638.9940 • Fax (603) 5638.9829
e-mail: hannamal@tm.net.my

Norway:

Tel. (23) 3811.00 • Fax (23) 3811.01
e-mail: hanna@hannainst.no

Singapore:

Tel. 6296.7118 • Fax 6291.6906
e-mail: hannaap@pacific.net.sg

South Africa:

Tel. (011) 615.6076 • Fax (011) 615.8582
e-mail: hannasa@mweb.co.za

United Kingdom:

Tel. (01525) 850.855 • Fax (01525) 853.668
e-mail: salesteam@hannainst.co.uk

USA:

Tel. (401) 765.7500 • Fax (401) 765.7575
e-mail: sales@hannainst.com

MAN83203 04/08