

Instruction Manual

HI 83208

Multiparameter Bench Photometer for Water Conditioning

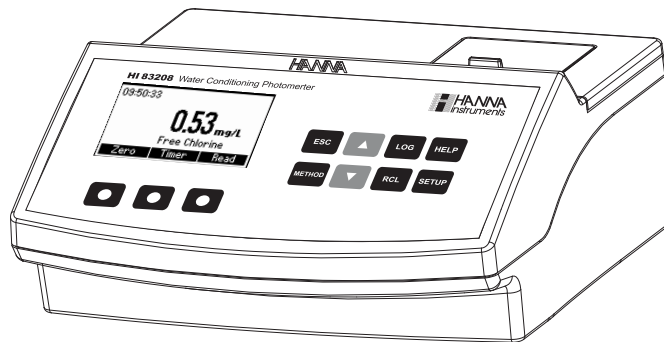

Dear Customer,

Thank you for choosing a Hanna product. Please read this instruction manual carefully before using the instrument. This manual will provide you with the necessary information for the correct use of the instrument. If you need additional technical information, do not hesitate to e-mail us at tech@hannainst.com.

TABLE OF CONTENTS

| | | | |
|--|----|---------------------------|----|
| PRELIMINARY EXAMINATION | 3 | IRON LR | 35 |
| ABBREVIATIONS | 3 | MANGANESE HR | 38 |
| GENERAL DESCRIPTION | 3 | MANGANESE LR | 40 |
| SPECIFICATIONS | 4 | MOLYBDENUM | 43 |
| PRECISION AND ACCURACY | 4 | NICKEL HR | 46 |
| PRINCIPLE OF OPERATION | 4 | NICKEL LR | 48 |
| FUNCTIONAL DESCRIPTION | 6 | NITRATE | 51 |
| TIPS FOR AN ACCURATE MEASUREMENT | 8 | DISSOLVED OXYGEN | 53 |
| HEALTH & SAFETY | 11 | pH | 55 |
| METHOD REFERENCE TABLE | 11 | PHOSPHATE HR | 57 |
| OPERATIONAL GUIDE | 12 | PHOSPHATE LR | 59 |
| SETUP | 14 | PHOSPHORUS | 61 |
| HELP MODE | 16 | SILICA | 63 |
| AMMONIA MR | 17 | SILVER | 66 |
| AMMONIA LR | 19 | ZINC | 69 |
| FREE CHLORINE | 21 | ERRORS AND WARNINGS | 71 |
| TOTAL CHLORINE | 24 | DATA MANAGEMENT | 72 |
| COPPER HR | 27 | STANDARD METHODS | 72 |
| COPPER LR | 29 | ACCESSORIES | 73 |
| FLUORIDE | 31 | WARRANTY | 75 |
| IRON HR | 33 | HANNA LITERATURE | 75 |

All rights are reserved. Reproduction in whole or in part is prohibited without the written consent of the copyright owner, Hanna Instruments Inc., Woonsocket, Rhode Island, 02895, USA.

PRELIMINARY EXAMINATION

Please examine this product carefully. Make sure that the instrument is not damaged. If any damage occurred during shipment, please notify your local Hanna Office.

Each Meter is supplied complete with:

- Two Sample Cuvettes and Caps
- Cloth for wiping cuvettes (1 pcs)
- 60 mL glass bottle for dissolved oxygen analysis (1 pcs)
- Scissors
- AC/DC Power Adapter
- Instruction Manual

Note: Save all packing material until you are sure that the instrument works correctly. Any defective item must be returned in its original packing with the supplied accessories.

ABBREVIATIONS

EPA: US Environmental Protection Agency

°F: degree Fahrenheit

°C: degree Celsius

µg/L: micrograms per liter (ppb)

mg/L: milligrams per liter (ppm)

g/L: grams per liter (ppt)

mL: milliliter

HR: high range

MR: medium range

LR: low range

PAN: 1-(2-pyridylazo)-2-naphthol

TPTZ: 2,4,6-tri-(2-pyridyl)-1,3,5-triazine

GENERAL DESCRIPTION

HI 83208 is a multiparameter bench photometer dedicated for Water Conditioning. It measures 23 different methods using specific liquid or powder reagents. The amount of reagent is precisely dosed to ensure maximum reproducibility.

HI 83208 bench photometer can be connected to a PC via an USB cable. The optional **HI 92000** Windows® Compatible Software helps users manage all their results.

HI 83208 has a powerful interactive user support that assists the user during the analysis process.

Each step in the measurement process is help supported. A tutorial mode is available in the Setup Menu.

SPECIFICATIONS

| | |
|-----------------------|--|
| Light Life | Life of the instrument |
| Light Detector | Silicon Photocell |
| Environment | 0 to 50°C (32 to 122°F); max 90% RH non-condensing |
| Power Supply | external 12 Vdc power adapter built-in rechargeable battery |
| Dimensions | 235 x 200 x 110 mm (9.2 x 7.87 x 4.33") |
| Weight | 0.9 Kg |

For specifications related to each method (e.g. range, resolution, etc.) refer to the related measurement section.

PRECISION AND ACCURACY

Precision is how closely repeated measurements agree with each other. Precision is usually expressed as standard deviation (SD).

Accuracy is defined as the nearness of a test result to the true value.

Although good precision suggests good accuracy, precise results can be inaccurate. The figure explains these definitions.

For each method, the precision is expressed in the related measurement section.

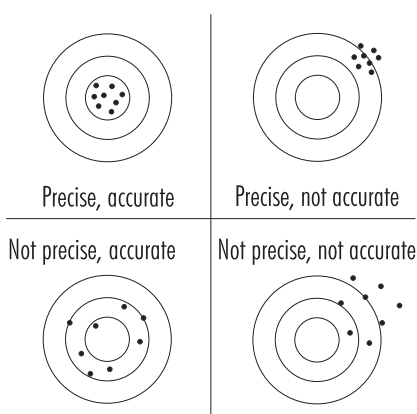

PRINCIPLE OF OPERATION

Absorption of light is a typical phenomenon of interaction between electromagnetic radiation and matter. When a light beam crosses a substance, some of the radiation may be absorbed by atoms, molecules or crystal lattices.

If pure absorption occurs, the fraction of light absorbed depends both on the optical path length through the matter and on the physical-chemical characteristics of substance according to the Lambert-Beer Law:

$$-\log \frac{I}{I_0} = \epsilon_{\lambda} c d$$

or

$$A = \epsilon_{\lambda} c d$$

Where:

- $-\log I/I_0 =$ Absorbance (A)
- $I_0 =$ intensity of incident light beam
- $I =$ intensity of light beam after absorption
- $\epsilon_\lambda =$ molar extinction coefficient at wavelength λ
- $c =$ molar concentration of the substance
- $d =$ optical path through the substance

Therefore, the concentration "c" can be calculated from the absorbance of the substance as the other factors are known.

Photometric chemical analysis is based on the possibility to develop an absorbing compound from a specific chemical reaction between sample and reagents.

Given that the absorption of a compound strictly depends on the wavelength of the incident light beam, a narrow spectral bandwidth should be selected as well as a proper central wavelength to optimize measurements.

The optical system of **HI 83208** is based on special subminiature tungsten lamps and narrow-band interference filters to guarantee both high performance and reliable results.

Four measuring channels allow a wide range of tests.

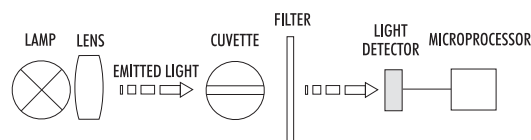

Instrument block diagram (optical layout)

A microprocessor controlled special tungsten lamp emits radiation which is first optically conditioned and beamed through the sample contained in the cuvette. The optical path is fixed by the diameter of the cuvette. Then the light is spectrally filtered to a narrow spectral bandwidth, to obtain a light beam of intensity I_0 or I . The photoelectric cell collects the radiation I that is not absorbed by the sample and converts it into an electric current, producing a potential in the mV range.

The microprocessor uses this potential to convert the incoming value into the desired measuring unit and to display it on the LCD.

The measurement process is carried out in two phases: first the meter is zeroed and then the actual measurement is performed.

The cuvette has a very important role because it is an optical element and thus requires particular attention. It is important that both the measurement and the calibration (zeroing) cuvette are optically identical to provide the same measurement conditions. Most methods use the same cuvette for both, so it is important that measurements take place in the same optical point. The instrument and the cuvette cap have special marks that must be aligned in order to obtain better reproducibility.

The surface of the cuvette must be clean and not scratched. This is to avoid measurement interference due to unwanted reflection and absorption of light. It is recommended not to touch the cuvette walls with hands.

Furthermore, in order to maintain the same conditions during the zeroing and the measurement phases, it is necessary to cap the cuvette to prevent any contamination.

FUNCTIONAL DESCRIPTION



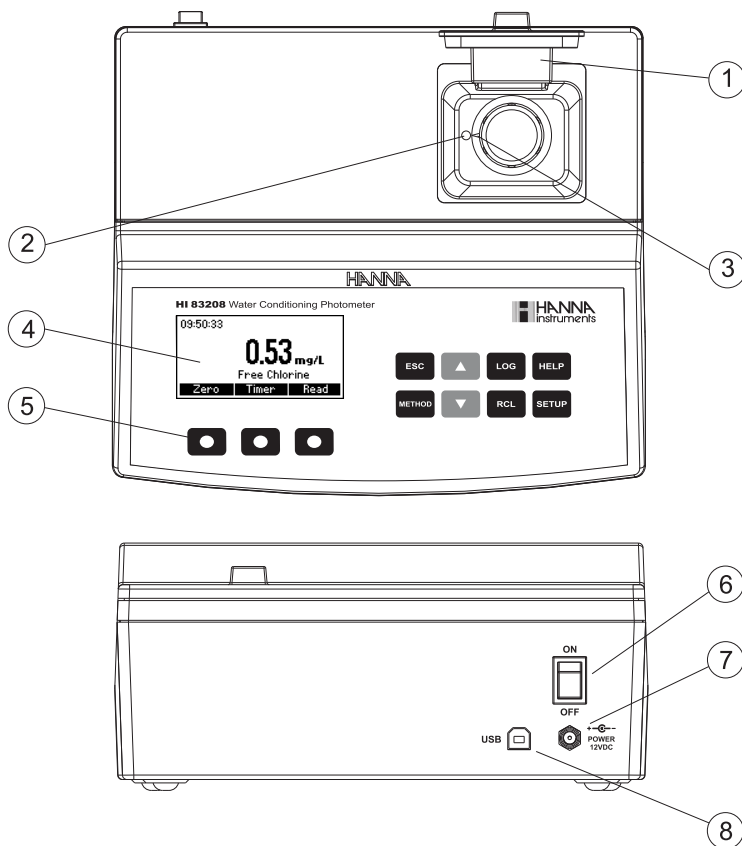





INSTRUMENT DESCRIPTION



- 1) Open Cuvette Lid
- 2) Indexing mark
- 3) Cuvette point
- 4) Liquid Crystal Display (LCD)
- 5) Splash proof keypad
- 6) ON/OFF power switch
- 7) Power input connector
- 8) USB connector

KEYPAD DESCRIPTION

The keypad contains 8 direct keys and 3 functional keys with the following functions:

-  Press to perform the function displayed above it on the LCD.
-  Press to exit the current screen.
-  Press to access the select method menu.
-  Press to move up in a menu or a help screen, to increment a set value, to access second level functions.
-  Press to move down in a menu or a help screen, to decrement a set value, to access second level functions.
-  Press to log the current reading.
-  Press to recall the log.
-  Press to display the help screen.
-  Press to access the setup screen.

TIPS FOR AN ACCURATE MEASUREMENT

The instructions listed below should be carefully followed during testing to ensure most accurate results.

- Color or suspended matter in large amounts may cause interference, and should be removed by treatment with active carbon and filtration.
- Ensure the cuvette is filled correctly: the liquid in the cuvette forms a convexity on the top; the bottom of this convexity must be at the same level as the 10 mL mark.

COLLECTING AND MEASURING SAMPLES

- In order to measure exactly 0.5 mL of reagent with the 1 mL syringe:
 - (a) push the plunger completely into the syringe and insert the tip into the solution.
 - (b) pull the plunger up until the lower edge of the seal is exactly on the 0.0 mL mark.
 - (c) take out the syringe and clean the outside of the syringe tip. Be sure that no drops are hanging on the tip of the syringe, if so eliminate them. Then, keeping the syringe in vertical position above the cuvette, push the plunger down into the syringe until the lower edge of the seal is exactly on the 0.5 mL mark. Now the exact amount of 0.5 mL has been added to the cuvette, even if the tip still contains some solution.

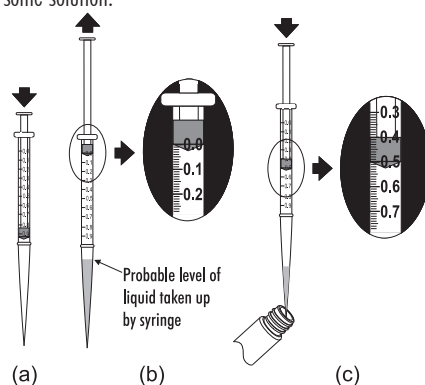

USING LIQUID AND POWDER REAGENTS

- Proper use of the dropper:
 - (a) for reproducible results, tap the dropper on the table for several times and wipe the outside of the dropper tip with a cloth.
 - (b) always keep the dropper bottle in a vertical position while dosing the reagent.

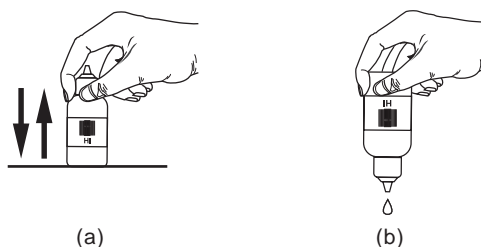

- Proper use of the powder reagent packet:
 - (a) use scissors to open the powder packet;
 - (b) push the edges of the packet to form a spout;
 - (c) pour out the content of the packet.

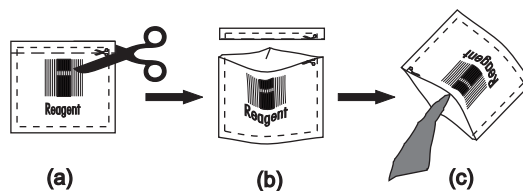

USING CUVETTES

- Proper mixing is very important for reproducibility of the measurements. The right way of mixing a cuvette is specified for each method in the related chapter.
 - (a) **invert the cuvette** a couple of times or for a specified time: hold the cuvette in the vertical position with the cap up. Turn the cuvette upside-down and wait for all of the solution to flow to the cap end, then return the cuvette to the upright vertical position and wait for all of the solution to flow to the cuvette bottom. This is one inversion. The correct speed for this mixing technique is 10-15 complete inversions in 30 seconds.

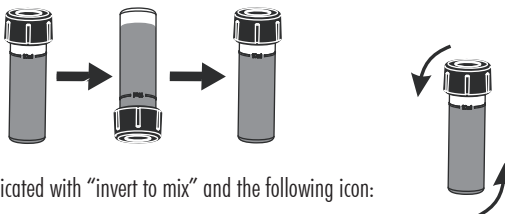

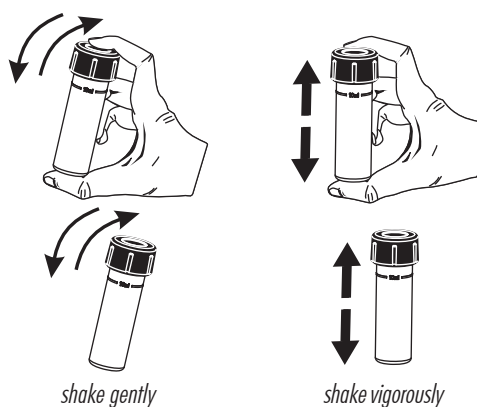

This mixing technique is indicated with “invert to mix” and the following icon:

- (b) **shaking the cuvette**, moving the cuvette up and down. The movement may be gentle or vigorous. This mixing method is indicated with “shake gently” or “shake vigorously”, and one of the following icons:

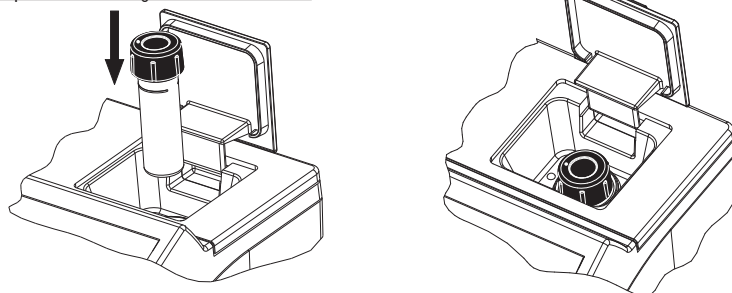

- Pay attention to push the cuvette completely down in the holder and to align the white point on the cap to the indexing mark on the meter.



- In order to avoid reagent leaking and to obtain more accurate measurements, close the cuvette first with the supplied HDPE plastic stopper  and then the black cap.
- Whenever the cuvette is placed into the measurement cell, it must be dry outside, and free of fingerprints, oil or dirt. Wipe it thoroughly with **HI 731318** or a lint-free cloth prior to insertion.
- Shaking the cuvette can generate bubbles in the sample, causing higher readings. To obtain accurate measurements, remove such bubbles by swirling or by gently tapping the cuvette.
- Do not let the reacted sample stand too long after reagent is added. For best accuracy, respect the timings described in each specific method.
- It is possible to take multiple readings in a row, but it is recommended to take a new zero reading for each sample and to use the same cuvette for zeroing and measurement when possible (for most precise results follow the measurement procedures carefully).
- Discard the sample immediately after the reading is taken, or the glass might become permanently stained.
- All the reaction times reported in this manual are at 25 °C (77 °F). In general, the reaction time should be increased for temperatures lower than 20 °C (68 °F), and decreased for temperatures higher than 25 °C (77 °F).

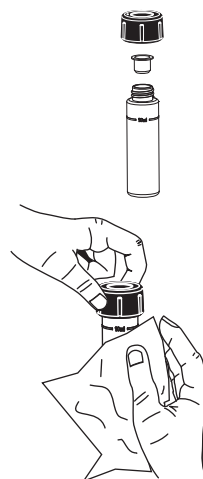

INTERFERENCES

- In the method measurement section the most common interferences that may be present in an average sample matrix have been reported. It may be that for a particular treatment process other compounds do interfere with the method of analysis.

HEALTH & SAFETY



- The chemicals contained in the reagent kits may be hazardous if improperly handled.
- Read the Material Safety Data Sheet (MSDS) before performing tests.
- **Safety equipment:** Wear suitable eye protection and clothing when required, and follow instructions carefully.
- **Reagent spills:** If a reagent spill occurs, wipe up immediately and rinse with plenty of water. If reagent contacts skin, rinse the affected area thoroughly with water. Avoid breathing released vapors.
- **Waste disposal:** for proper disposal of reagent kits and reacted samples, refer to the Material Safety Data Sheet (MSDS).

METHOD REFERENCE TABLE

| Method | Method description | Page |
|--------|--------------------|------|
| 1 | Ammonia MR | 17 |
| 2 | Ammonia LR | 19 |
| 3 | Free Chlorine | 21 |
| 4 | Total Chlorine | 24 |
| 5 | Copper HR | 27 |
| 6 | Copper LR | 29 |
| 7 | Fluoride | 31 |
| 8 | Iron HR | 33 |
| 9 | Iron LR | 35 |
| 10 | Manganese HR | 38 |
| 11 | Manganese LR | 40 |
| 12 | Molybdenum | 43 |

| Method | Method description | Page |
|--------|--------------------|------|
| 13 | Nickel HR | 46 |
| 14 | Nickel LR | 48 |
| 15 | Nitrate | 51 |
| 16 | Dissolved Oxygen | 53 |
| 17 | pH | 55 |
| 18 | Phosphate HR | 57 |
| 19 | Phosphate LR | 59 |
| 20 | Phosphorus | 61 |
| 21 | Silica | 63 |
| 22 | Silver | 66 |
| 23 | Zinc | 69 |

OPERATIONAL GUIDE

POWER CONNECTION AND BATTERY MANAGEMENT

The meter can be powered from an AC/DC adapter (included) or from the built-in rechargeable battery.

Note: Always turn the meter off before unplugging it to ensure no data is lost.

When the meter switches ON, it verifies if the power supply adapter is connected. The battery icon on the LCD will indicate the battery status:

- battery is charging from external adapter
- battery fully charged (meter connected to AC/DC adapter)

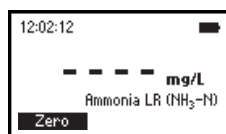
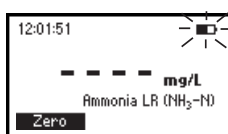

- battery capacity (no external adapter)
- battery Low (no external adapter)

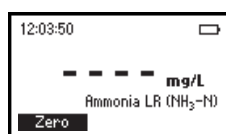
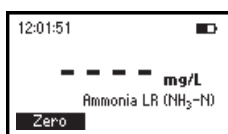

- battery Dead (no external adapter)

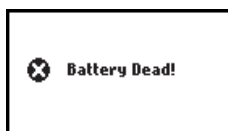

METHOD SELECTION

- Turn the instrument ON via the ON/OFF power switch.
- The meter will perform an autodiagnostic test. During this test, the Hanna Instrument logo will appear on the LCD. After 5 seconds, if the test was successful, the last method used will appear on the display.
- In order to select the desired method press the **METHOD** key and a screen with the available methods will appear.
- Press the ▲ ▼ keys to highlight the desired method. Press **Select**.

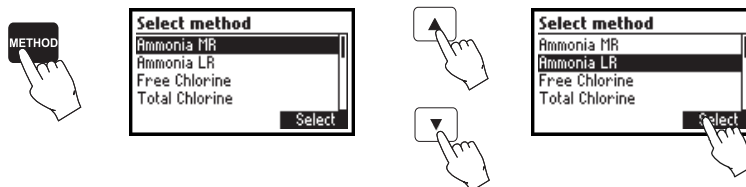

- After the desired method is selected, follow the measurement described in the related section.
- Before performing a test you should read all the instructions carefully.

DATA MANAGEMENT

The instrument features a data log function to help you keep track of all your analysis. The data log can hold 200 individual measurements. Storing, viewing and deleting the data is possible using the **LOG** and **RCL** keys.

Storing data: You can store only a valid measurement. Press **LOG** and the last valid measurement will be stored with date and time stamps.

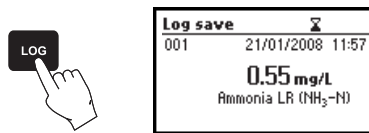

Viewing and deleting: You can view and delete the data log by pressing the **RCL** key. You can only delete the last saved measurement. Additionally, you can delete the data records all at once.

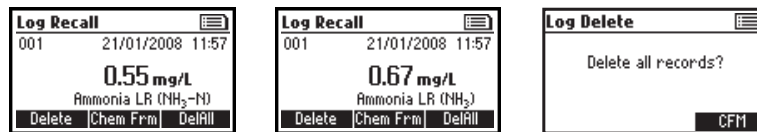

CHEMICAL FORM

Chemical form conversion factors are pre-programmed into the instrument and are method specific. In order to view the displayed result in the desired chemical form press **▲** or **▼** to access the second level functions and then press the **Chem Frm** functional key to toggle between the available chemical forms for the selected method.

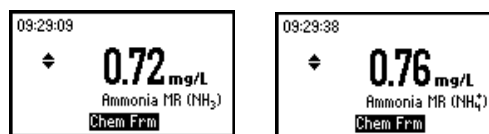

SETUP

In the Setup mode the instrument's parameters can be changed. Some parameters affect the measuring sequence and others are general parameters that change the behavior or appearance of the instrument.

Press **SETUP** to enter the setup mode.

Press **ESC** or **SETUP** to return to the main screen.

A list of setup parameters will be displayed with currently configured settings. Press **HELP** for additional information.

Press the ▲ ▼ keys to select a parameter and change the value as follows:



Backlight

Values: 0 to 8.

Press the **Modify** key to access the backlight value.

Use the ◀ ▶ functional keys or the ▲ ▼ keys to increase or decrease the value.

Press the **Accept** key to confirm or **ESC** to return to the setup menu without saving the new value.

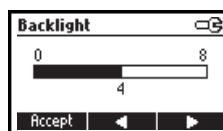
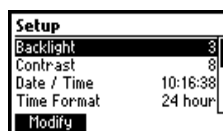

Contrast

Values: 0 to 20.

This option is used to set the display's contrast.

Press the **Modify** key to change the display's contrast.

Use the ◀ ▶ functional keys or the ▲ ▼ keys to increase or decrease the value.

Press the **Accept** key to confirm the value or **ESC** to return to the setup menu without saving the new value.

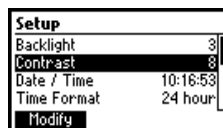

Date / Time

This option is used to set the instrument's date and time.

Press the **Modify** key to change the date/time.

Press the ◀ ▶ functional keys to highlight the value to be modified (year, month, day, hour, minute or second). Use the ▲ ▼ keys to change the value.

Press the **Accept** key to confirm or **ESC** to return to the setup without saving the new date or time.

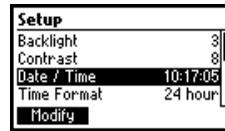

Time format

Option: AM/PM or 24 hour.

Press the functional key to select the desired time format.

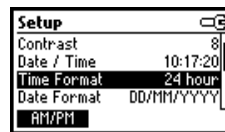

Date format

Press the **Modify** key to change the Date Format.

Use the ▲ ▼ keys to select the desired format.

Press the **Accept** key to confirm or **ESC** to return to the setup menu without saving the new format.

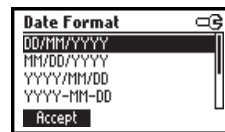
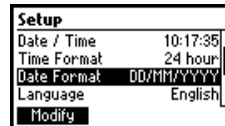

Language

Press the corresponding key to change the language.

If the new language cannot be loaded, the previously selected language will be reloaded.



Tutorial

Option: Enable or Disable.

If enabled this option will provide the user short guide related to the current screen.

Press the functional key to enable/disable the tutorial mode.

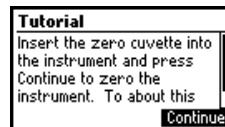
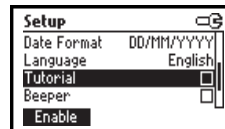

Beeper

Option: Enable or Disable.

When enabled, a short beep is heard every time a key is pressed.

A long beep alert sounds when the pressed key is not active or an error condition is detected.

Press the functional key to enable/disable the beeper.

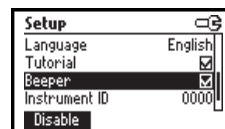

Instrument ID

Option: 0 to 9999.

This option is used to set the instrument's ID (identification number). The instrument ID is used while exchanging data with a PC.

Press the **Modify** key to access the instrument ID screen. Press the **▲ ▼** keys in order to set the desired value.

Press the **Accept** key to confirm the value or **ESC** to return to the setup menu without saving the new value.

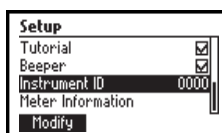

Meter information

Press the **Select** key to view the instrument model, firmware version, language version and instrument serial number.

Press **ESC** to return to the Setup mode.

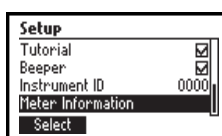

HELP MODE

HI 83208 offers an interactive contextual help mode that assists the user at any time.

To access the help screens press **HELP**.

The instrument will display additional information related to the current screen. To read all the available information, scroll the text using the **▲ ▼** keys.

Press the **Support** key to access a screen with Hanna service centers and their contact details.

Press the **Accessories** key to access a list of instrument reagents and accessories.

To exit support or accessories screens press **ESC** and the instrument will return to the previous help screen.

To exit help mode press the **HELP** or **ESC** key again and the meter will return to the previously selected screen.

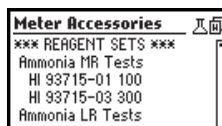
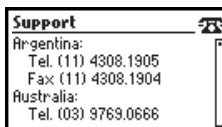
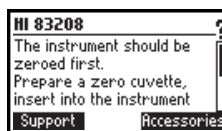

AMMONIA MEDIUM RANGE

SPECIFICATIONS

| | |
|---------------------|--|
| Range | 0.00 to 10.00 mg/L |
| Resolution | 0.01 mg/L |
| Accuracy | ±0.05 mg/L ±5% of reading at 25 °C |
| Typical EMC | ±0.01 mg/L |
| Deviation | |
| Light Source | Tungsten lamp with narrow band interference filter @ 420 nm |
| Method | Adaptation of the <i>ASTM Manual of Water and Environmental Technology, D1426-92</i> , Nessler method. The reaction between ammonia and reagents causes a yellow tint in the sample. |

REQUIRED REAGENTS

| Code | Description | Quantity |
|-------------|----------------|---------------------------------|
| HI 93715A-0 | First Reagent | 4 drops (6 drops for seawater) |
| HI 93715B-0 | Second Reagent | 4 drops (10 drops for seawater) |

REAGENT SETS

HI 93715-01 Reagents for 100 tests

HI 93715-03 Reagents for 300 tests

For other accessories see page 73.

MEASUREMENT PROCEDURE

- Select the *Ammonia MR* method using the procedure described in the *Method Selection* section (see page 12).
- Fill the cuvette with 10 mL of unreacted sample (up to the mark) and replace the cap.
- Place the cuvette into the holder and close the lid.

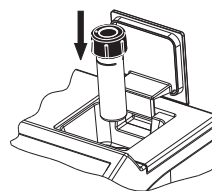

- Press the **Zero** key. The display will show “-0.0-” when the meter is zeroed and ready for measurement.

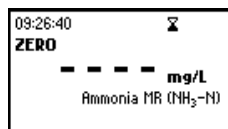
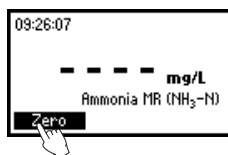

- Remove the cuvette.
- Add 4 drops of HI 93715A-0 First reagent (6 drops for seawater analysis). Replace the cap and mix the solution.
- Add 4 drops of HI 93715B-0 Second reagent (10 drops for seawater analysis). Replace the cap and mix the solution.

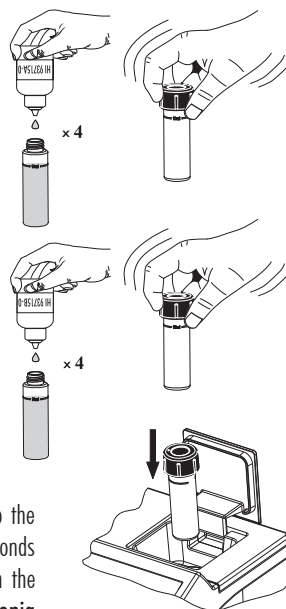

- Reinsert the cuvette into the instrument.
- Press **Timer** and the display will show the countdown prior to the measurement or, alternatively, wait for 3 minutes and 30 seconds and press **Read**. When the timer ends the meter will perform the reading. The instrument displays the results in **mg/L of ammonia nitrogen (NH₃-N)**.

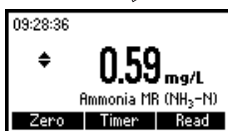
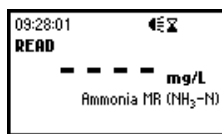
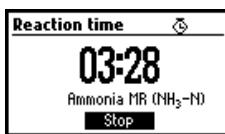
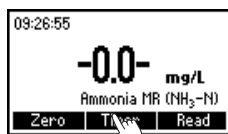

- Press ▲ or ▼ to access the second level functions.
- Press the **Chem Frm** key to convert the result in mg/L of ammonia (NH₃) and ammonium (NH₄⁺).

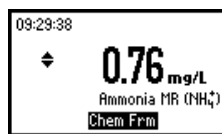
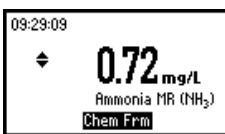
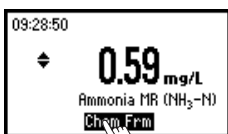

- Press ▲ or ▼ to return to the measurement screen.

INTERFERENCES

Interference may be caused by:

acetone, alcohols, aldehydes, glycine, hardness above 1 g/L, iron, organic chloramines, sulfide, various aliphatic and aromatic amines.

AMMONIA LOW RANGE

SPECIFICATIONS

| | |
|---------------------|--|
| Range | 0.00 to 3.00 mg/L |
| Resolution | 0.01 mg/L |
| Accuracy | ± 0.04 mg/L $\pm 4\%$ of reading at 25 °C |
| Typical EMC | ± 0.01 mg/L |
| Deviation | |
| Light Source | Tungsten lamp with narrow band interference filter @ 420 nm |
| Method | Adaptation of the <i>ASTM Manual of Water and Environmental Technology, D1426-92</i> , Nessler method. The reaction between ammonia and reagents causes a yellow tint in the sample. |

REQUIRED REAGENTS

| Code | Description | Quantity |
|-------------|----------------|---------------------------------|
| HI 93700A-0 | First Reagent | 4 drops (6 drops for seawater) |
| HI 93700B-0 | Second Reagent | 4 drops (10 drops for seawater) |

REAGENT SETS

HI 93700-01 Reagents for 100 tests

HI 93700-03 Reagents for 300 tests

For other accessories see page 73.

MEASUREMENT PROCEDURE

- Select the *Ammonia LR* method using the procedure described in the *Method Selection* section (see page 12).
- Fill the cuvette with 10 mL of unreacted sample (up to the mark) and replace the cap.
- Place the cuvette into the holder and close the lid.

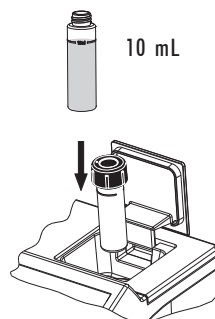

- Press the **Zero** key. The display will show “-0.0-” when the meter is zeroed and ready for measurement.

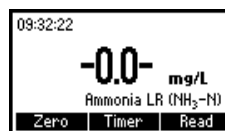
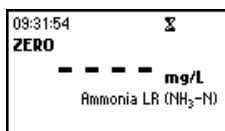
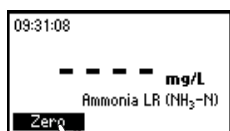

- Remove the cuvette.
- Add 4 drops of HI 93700A-0 First reagent (6 drops for seawater analysis). Replace the cap and mix the solution.
- Add 4 drops of HI 93700B-0 Second reagent (10 drops for seawater analysis). Replace the cap and mix the solution.
- Reinsert the cuvette into the instrument.

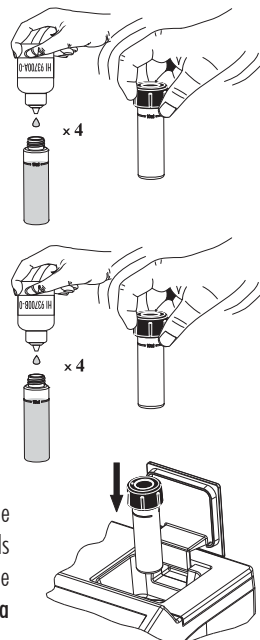

- Press **Timer** and the display will show the countdown prior to the measurement or, alternatively, wait for 3 minutes and 30 seconds and press **Read**. When the timer ends the meter will perform the reading. The instrument displays the results in **mg/L of ammonia nitrogen (NH₃-N)**.

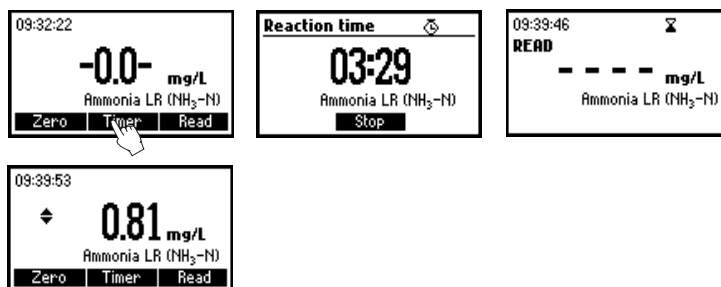

- Press ▲ or ▼ to access the second level functions.
- Press the **Chem Frm** key to convert the result in mg/L of ammonia (NH₃) and ammonium (NH₄⁺).

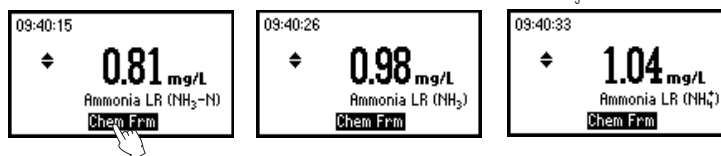

- Press ▲ or ▼ to return to the measurement screen.

INTERFERENCES

Interference may be caused by: acetone, alcohols, aldehydes, glycine, hardness above 1 g/L, iron, organic chloramines, sulfide, various aliphatic and aromatic amines.

FREE CHLORINE

SPECIFICATIONS

| | |
|--------------|--|
| Range | 0.00 to 2.50 mg/L |
| Resolution | 0.01 mg/L |
| Accuracy | ± 0.03 mg/L $\pm 3\%$ of reading at 25 °C |
| Typical EMC | ± 0.01 mg/L |
| Deviation | |
| Light Source | Tungsten lamp with narrow band interference filter @ 525 nm |
| Method | Adaptation of the <i>EPA DPD method 330.5</i> . The reaction between free chlorine and the DPD reagent causes a pink tint in the sample. |

REQUIRED REAGENTS

POWDER:

| Code | Description | Quantity |
|------------|-------------|----------|
| HI 93701-0 | DPD | 1 packet |

LIQUID:

| Code | Description | Quantity |
|-------------|----------------|----------|
| HI 93701A-F | DPD1 Indicator | 3 drops |
| HI 93701B-F | DPD1 Buffer | 3 drops |

REAGENT SETS

- HI 93701-F Reagents for 300 tests (liquid)
 - HI 93701-01 Reagents for 100 tests (powder)
 - HI 93701-03 Reagents for 300 tests (powder)
- For other accessories see page 73.

MEASUREMENT PROCEDURE

- Select the *Free Chlorine* method using the procedure described in the *Method Selection* section (see page 12).
- Fill the cuvette with 10 mL of unreacted sample (up to the mark) and replace the cap.
- Place the cuvette into the holder and close the lid.

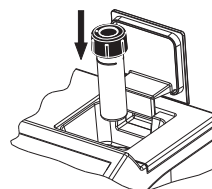

- Press the **Zero** key. The meter will show “-0.0-” when the meter is zeroed and ready for measurement.

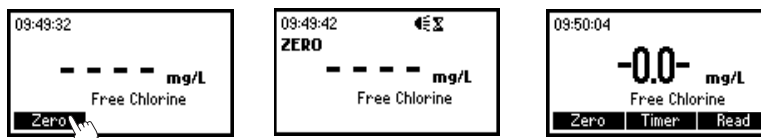

- Remove the cuvette.

Powder reagents procedure

- Add the content of one packet of HI 93701-0 DPD reagent. Replace the cap and shake gently for 20 seconds (or 2 minutes for seawater analysis).

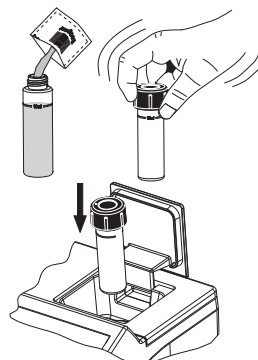

- Press **Timer** and the display will show the countdown prior to the measurement or, alternatively, wait for 1 minute and press **Read**. When the timer ends the meter will perform the reading. The instrument displays the results in **mg/L** of free chlorine.



Liquid reagents procedure

- To an empty cuvette add 3 drops of HI 93701A-F DPD1 indicator and 3 drops of HI 93701B-F DPD1 buffer. Swirl gently to mix, and immediately add 10 mL of unreacted sample. Replace the cap and shake gently again.

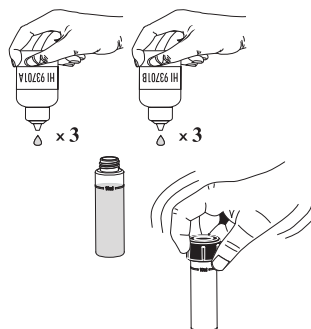

- Reinsert the cuvette into the instrument.

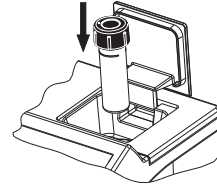

- Press **Read** to start the reading. The instrument displays the results in **mg/L of free chlorine**.

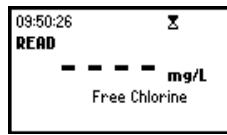

INTERFERENCES

Interference may be caused by: Bromine, Iodine, Ozone, Oxidized forms of Chromium and Manganese.

In case of water with hardness greater than 500 mg/L CaCO₃, shake the sample for approximately 2 minutes after adding the powder reagent.

In case of water with alkalinity greater than 250 mg/L CaCO₃ or acidity greater than 150 mg/L CaCO₃, the color of the sample may develop only partially, or may rapidly fade. To resolve this, neutralize the sample with diluted HCl or NaOH.

TOTAL CHLORINE

SPECIFICATIONS

| | |
|--------------|---|
| Range | 0.00 to 3.50 mg/L |
| Resolution | 0.01 mg/L |
| Accuracy | ± 0.03 mg/L $\pm 3\%$ of reading at 25 °C |
| Typical EMC | ± 0.01 mg/L |
| Deviation | |
| Light Source | Tungsten lamp with narrow band interference filter @ 525 nm |
| Method | Adaptation of the <i>EPA DPD method 330.5</i> . The reaction between the chlorine and the DPD reagent causes a pink tint in the sample. |

REQUIRED REAGENTS

POWDER:

| Code | Description | Quantity |
|------------|-------------|----------|
| HI 93711-0 | DPD | 1 packet |

LIQUID:

| Code | Description | Quantity |
|-------------|----------------|----------|
| HI 93701A-T | DPD1 indicator | 3 drops |
| HI 93701B-T | DPD1 buffer | 3 drops |
| HI 93701C | DPD3 solution | 1 drop |

REAGENT SETS

- HI 93701-T Reagents for 300 total chlorine tests (liquid)
- HI 93711-01 Reagents for 100 total chlorine tests (powder)
- HI 93711-03 Reagents for 300 total chlorine tests (powder)

For other accessories see page 73.

MEASUREMENT PROCEDURE

- Select the *Total Chlorine* method using the procedure described in the *Method Selection* section (see page 12).
- Fill the cuvette with 10 mL of unreacted sample (up to the mark) and replace the cap.
- Place the cuvette into the holder and close the lid.

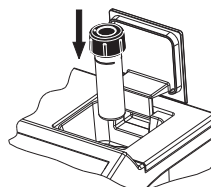

- Press the **Zero** key. The meter will show “-0.0-” when the meter is zeroed and ready for measurement.

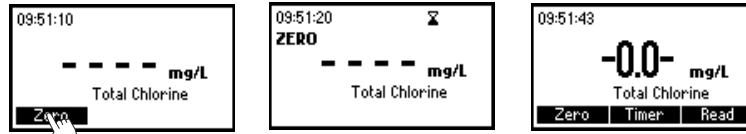

- Remove the cuvette.

Powder reagents procedure

- Add 1 packet of HI 93711-0 DPD reagent. Replace the cap and shake gently for 20 seconds (or 2 minutes for seawater analysis).
- Reinsert the cuvette into the instrument.
- Press **Timer** and the display will show the countdown prior to the measurement or, alternatively, wait for 2 minutes and 30 seconds and press **Read**. When the timer ends the meter will perform the reading. The instrument displays the results in **mg/L of total chlorine**.

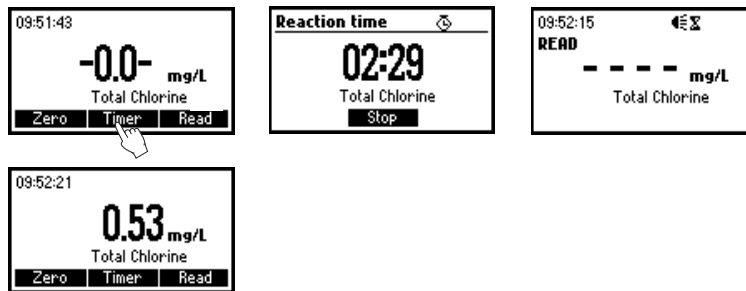
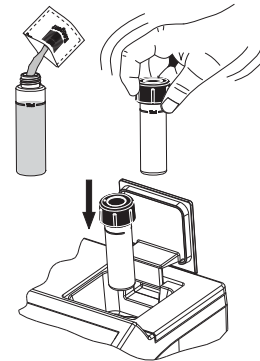

Liquid reagents procedure

- To an empty cuvette add 3 drops of HI 93701A-T DPD1 indicator, 3 drops of HI 93701B-T DPD1 buffer and 1 drop of HI 93701C DPD3 solution. Swirl gently to mix and **immediately** add 10 mL of unreacted sample. Replace the cap and shake gently again.

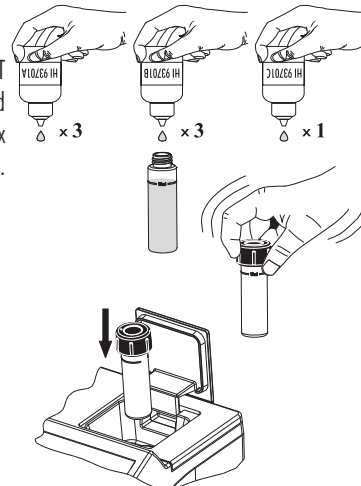

- Reinsert the cuvette into the instrument.

- Press **Timer** and the display will show the countdown prior to the measurement or, alternatively, wait for 2 minutes and 30 seconds and press **Read**. When the timer ends the meter will perform the reading.



- The instrument displays the results in mg/L of total chlorine.



Note: free and total chlorine have to be measured separately with fresh unreacted samples following the related procedure if both values are requested.

INTERFERENCES

Interference may be caused by: Bromine, Iodine, Ozone, Oxidized forms of Chromium and Manganese.

In case of water with hardness greater than 500 mg/L CaCO₃, shake the sample for approximately 2 minutes after adding the powder reagent.

In case of water with alkalinity greater than 250 mg/L CaCO₃ or acidity greater than 150 mg/L CaCO₃, the color of the sample may develop only partially, or may rapidly fade. To resolve this, neutralize the sample with diluted HCl or NaOH.

COPPER HIGH RANGE

SPECIFICATIONS

| | |
|---------------------|--|
| Range | 0.00 to 5.00 mg/L |
| Resolution | 0.01 mg/L |
| Accuracy | ± 0.02 mg/L $\pm 4\%$ of reading at 25 °C |
| Typical EMC | ± 0.01 mg/L |
| Deviation | |
| Light Source | Tungsten lamp with narrow band interference filter @ 575 nm |
| Method | Adaptation of the <i>EPA method</i> . The reaction between copper and the bicinchoninate reagent causes a purple tint in the sample. |

REQUIRED REAGENTS

| <u>Code</u> | <u>Description</u> | <u>Quantity</u> |
|-------------|--------------------|-----------------|
| HI 93702-0 | Bicinchoninate | 1 packet |

REAGENT SETS

HI 93702-01 Reagents for 100 tests

HI 93702-03 Reagents for 300 tests

For other accessories see page 73.

MEASUREMENT PROCEDURE

- Select the *Copper HR* method using the procedure described in the *Method Selection* section (see page 12).
- Fill the cuvette with 10 mL of unreacted sample (up to the mark) and replace the cap.
- Place the cuvette into the holder and close the lid.

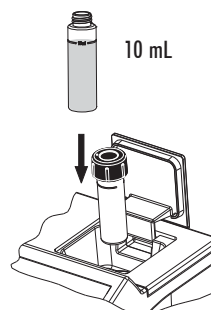

- Press the **Zero** key. The meter will show “-0.0-” when the meter is zeroed and ready for measurement.

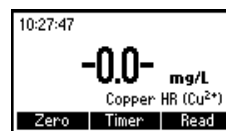
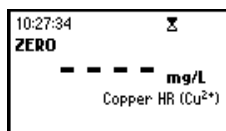
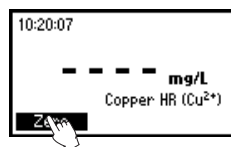

- Remove the cuvette.
- Add the content of one packet of HI 93702-0 Bicinchoninate. Replace the cap and shake gently for about 15 seconds.

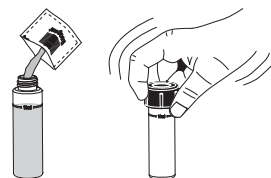

- Reinsert the cuvette into the instrument.

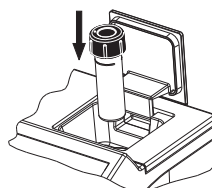

- Press **Timer** and the display will show the countdown prior to the measurement or, alternatively, wait for 45 seconds and press **Read**. When the timer ends the meter will perform the reading.

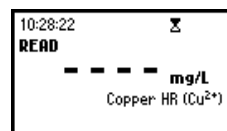
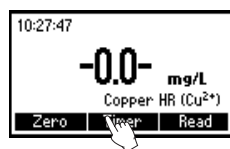

- The instrument displays the results in **mg/L** of copper.



INTERFERENCES

Interference may be caused by:

Silver

Cyanide

For samples overcoming buffering capacity of reagent (around pH 6.8), pH should be adjusted between 6 and 8.

COPPER LOW RANGE

SPECIFICATIONS

| | |
|------------------------------|--|
| Range | 0 to 1000 µg/L |
| Resolution | 1 µg/L |
| Accuracy | ±10 µg/L ±5% of reading at 25 °C |
| Typical EMC Deviation | ±1 µg/L |
| Light Source | Tungsten lamp with narrow band interference filter @ 575 nm |
| Method | Adaptation of the <i>EPA method</i> . The reaction between copper and the bicinchoninate reagent causes a purple tint in the sample. |

REQUIRED REAGENTS

| <u>Code</u> | <u>Description</u> | <u>Quantity</u> |
|-------------|--------------------|-----------------|
| HI 95747-0 | Bicinchoninate | 1 packet |

REAGENT SETS

HI 95747-01 Reagents for 100 tests

HI 95747-03 Reagents for 300 tests

For other accessories see page 73.

MEASUREMENT PROCEDURE

- Select the *Copper LR* method using the procedure described in the *Method Selection* section (see page 12).
- Fill the cuvette with 10 mL of unreacted sample (up to the mark) and replace the cap.
- Place the cuvette into the holder and close the lid.

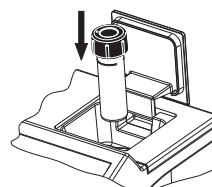

- Press the **Zero** key. The meter will show “-0.0-” when the meter is zeroed and ready for measurement.

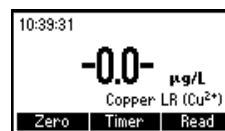
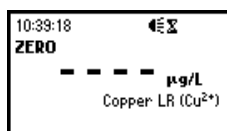
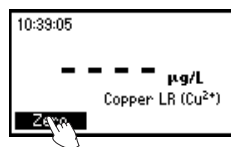

- Remove the cuvette.
- Add the content of one packet of HI 95747-0 Bicinchoninate. Replace the cap and shake gently for about 15 seconds.

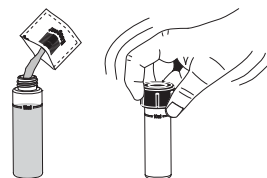

- Reinsert the cuvette into the instrument.

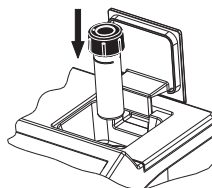

- Press **Timer** and the display will show the countdown prior to the measurement or, alternatively, wait for 45 seconds and press **Read**. When the timer ends the meter will perform the reading.

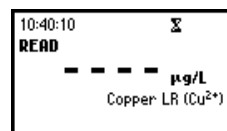
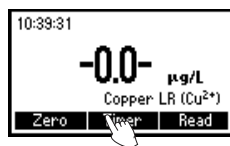

- The instrument displays the results in $\mu\text{g/L}$ of copper.

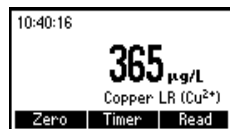

INTERFERENCES

Interference may be caused by:

Silver

Cyanide

For samples overcoming buffering capacity of reagent (around pH 6.8), pH should be adjusted between 6 and 8.

FLUORIDE

SPECIFICATIONS

| | |
|--------------|---|
| Range | 0.00 to 2.00 mg/L |
| Resolution | 0.01 mg/L |
| Accuracy | ± 0.03 mg/L $\pm 3\%$ of reading at 25 °C |
| Typical EMC | ± 0.01 mg/L |
| Deviation | |
| Light Source | Tungsten lamp with narrow band interference filter @ 575 nm |
| Method | Adaptation of the <i>Standard Methods for the Examination of Water and Wastewater, 18th edition</i> , SPADNS method. The reaction between fluoride and the liquid reagent causes a red tint in the sample. |

REQUIRED REAGENT

| Code | Description | Quantity |
|------------|----------------|----------|
| HI 93729-0 | SPADNS Reagent | 4 mL |

REAGENT SETS

HI 93729-01 Reagents for 100 tests

HI 93729-03 Reagents for 300 tests

For other accessories see page 73.

MEASUREMENT PROCEDURE

- Select the *Fluoride* method using the procedure described in the *Method Selection* section (see page 12).
- Add 2 mL of HI 93729-0 SPADNS reagent to two cuvettes.
- Fill one of the cuvettes with distilled water up to the mark, replace the cap and invert several times to mix.
- Fill the other cuvette with sample up to the mark, replace the cap and invert several times to mix.
- Place the cuvette with the reacted distilled water (# 1) into the holder and close the lid.

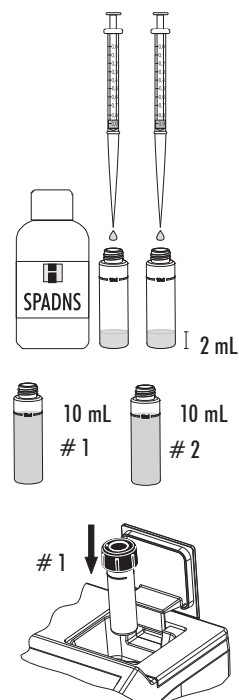

- Press **Timer** and the display will show the countdown prior to zeroing or, alternatively, wait for two minutes and press **Zero**. The display will show “-0.0-” when the meter is zeroed and ready for measurement.

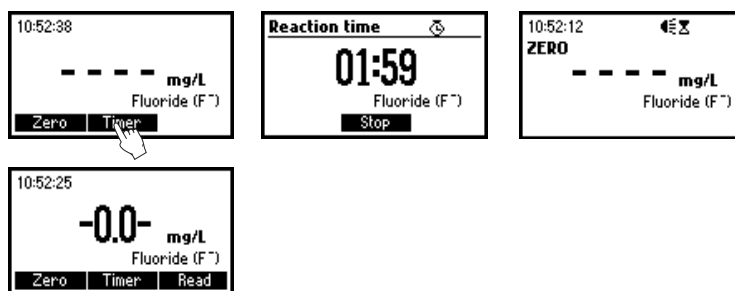

- Remove the cuvette.
- Insert the other cuvette (# 2) with the reacted sample into the instrument.

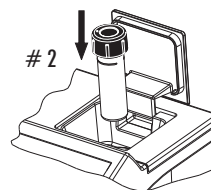

- Press **Read** to start reading. The instrument displays the results in mg/L of fluoride.

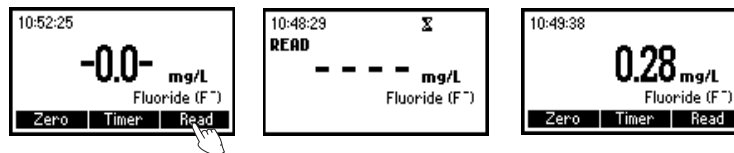

Note: For wastewater or seawater samples, before performing measurements, distillation is required. For most accurate results, use two graduated pipettes to deliver exactly 8 mL of distilled water and 8 mL of sample.

INTERFERENCES

Interferences may be caused by:

Alkalinity (as CaCO₃) above 5000 mg/L

Aluminum above 0.1 mg/L

Iron, ferric above 10 mg/L

Chloride above 700 mg/L

Phosphate, ortho above 16 mg/L

Sodium hexametaphosphate above 1.0 mg/L

Sulfate above 200 mg/L

Highly colored and turbid samples may require distillation

Highly alkaline samples can be neutralized with nitric acid.

IRON HIGH RANGE

SPECIFICATIONS

| | |
|---------------------|---|
| Range | 0.00 to 5.00 mg/L |
| Resolution | 0.01 mg/L |
| Accuracy | ±0.04 mg/L ±2% of reading at 25 °C |
| Typical EMC | ±0.01 mg/L |
| Deviation | |
| Light Source | Tungsten lamp with narrow band interference filter @ 525 nm |
| Method | Adaptation of the <i>EPA Phenantroline method 315B</i> , for natural and treated waters. The reaction between iron and reagents causes an orange tint in the sample. |

REQUIRED REAGENTS

| Code | Description | Quantity |
|------------|----------------|----------|
| HI 93721-0 | Powder Reagent | 1 packet |

REAGENT SETS

HI 93721-01 Reagents for 100 tests
 HI 93721-03 Reagents for 300 tests
 For other accessories see page 73.

MEASUREMENT PROCEDURE

- Select the *Iron HR* method using the procedure described in the *Method Selection* section (see page 12).
- Fill the cuvette with 10 mL of unreacted sample (up to the mark) and replace the cap.
- Place the cuvette into the holder and close the lid.

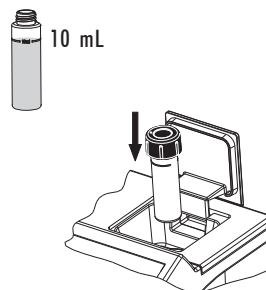

- Press the **Zero** key. The display will show “-0.0-” the meter is zeroed and ready for measurement.

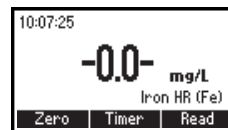
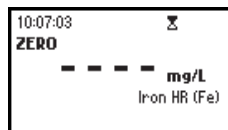
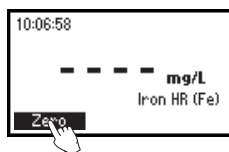

- Remove the cuvette and add the content of one packet of HI 93721-0 reagent. Replace the cap and shake until dissolution is complete.

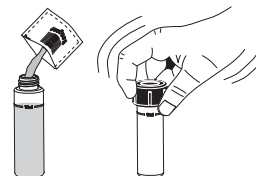

- Reinsert the cuvette into the instrument.

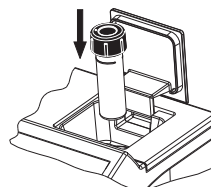

- Press **Timer** and the display will show the countdown prior to the measurement or, alternatively, wait for 3 minutes and press **Read**. When the timer ends the meter will perform the reading.

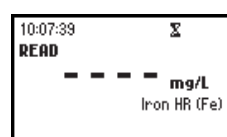
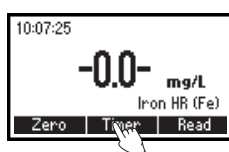

- The instrument displays concentration in **mg/L** of iron.

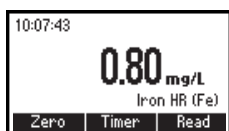

INTERFERENCES

Interference may be caused by:

Molybdate Molybdenum above 50 ppm

Calcium above 10000 ppm (as CaCO₃)

Magnesium above 100000 ppm (as CaCO₃)

Chloride above 185000 ppm.

IRON LOW RANGE

SPECIFICATIONS

| | |
|--------------|--|
| Range | 0 to 400 $\mu\text{g/L}$ |
| Resolution | 1 $\mu\text{g/L}$ |
| Accuracy | $\pm 10 \mu\text{g/L} \pm 8\%$ of reading at 25 °C |
| Typical EMC | $\pm 1 \mu\text{g/L}$ |
| Deviation | |
| Light Source | Tungsten lamp with narrow band interference filter @ 575 nm |
| Method | Adaptation of the TPTZ Method. The reaction between iron and the reagent causes a violet tint in the sample. |

REQUIRED REAGENTS

| Code | Description | Quantity |
|------------|--------------|-----------|
| HI 93746-0 | TPTZ Reagent | 2 packets |

REAGENT SETS

HI 93746-01 Reagents for 50 tests

HI 93746-03 Reagents for 150 tests

For other accessories see page 73.

MEASUREMENT PROCEDURE

- Select the *Iron LR* method using the procedure described in the *Method Selection* section (see page 12).
- Fill one graduated mixing cylinder up to the 25 mL mark with deionized water.
- Add the content of one packet of HI 93736-0 TPTZ reagent, close the cylinder and shake vigorously for 30 seconds. This is the blank.
- Fill a cuvette with 10 mL of the blank up to the mark and replace the cap.
- Place the cuvette into the holder and close the lid.

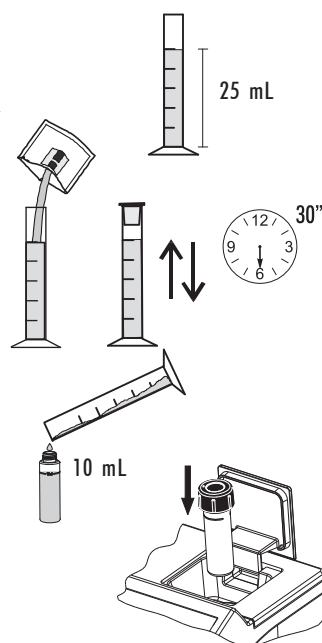

- Press the **Zero** key. The display will show “-0.0-” when the meter is zeroed and ready for measurement.

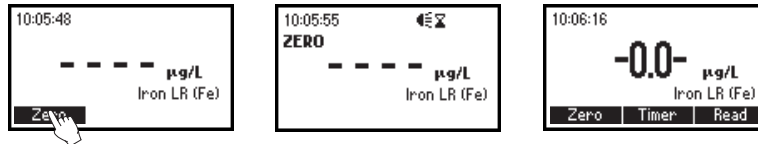

- Remove the cuvette.
- Fill another graduated mixing cylinder up to the 25 mL mark with the sample.

- Add the content of one packet of HI 93746-0 TPTZ reagent, close the cylinder and shake vigorously for 30 seconds. This is the reacted sample.

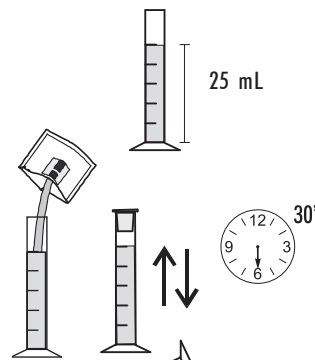

- Fill a cuvette with 10 mL of the reacted sample up to the mark and replace the cap.
- Insert the sample into the instrument.

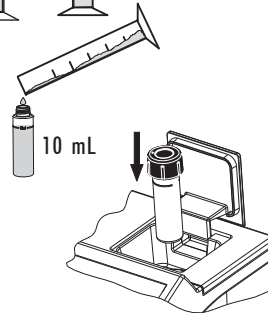

- Press **Timer** and the display will show the countdown prior to the measurement or, alternatively, wait for 30 seconds and press **Read**. When the timer ends the meter will perform the reading. The instrument displays concentration in $\mu\text{g/L}$ of iron.

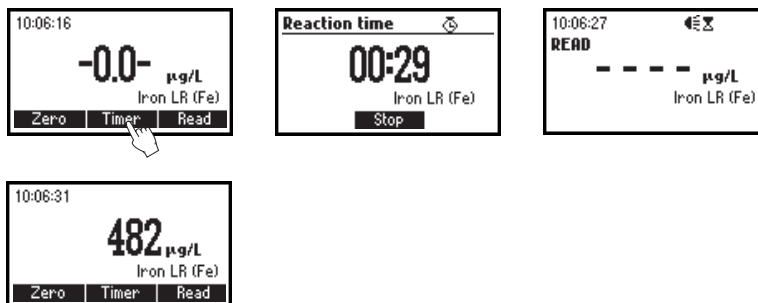

INTERFERENCES

Interference may be caused by:

Cadmium above 4.0 mg/L

Chromium³⁺ above 0.25 mg/L

Chromium⁶⁺ above 1.2 mg/L

Cobalt above 0.05 mg/L

Copper above 0.6 mg/L

Cyanide above 2.8 mg/L

Manganese above 50.0 mg/L

Mercury above 0.4 mg/L

Molybdenum above 4.0 mg/L

Nickel above 1.0 mg/L

Nitrite ion above 0.8 mg/L

Sample pH should be between 3 and 4 to avoid developed color to fade or turbidity formation.

MANGANESE HIGH RANGE

SPECIFICATIONS

| | |
|------------------------------|--|
| Range | 0.0 to 20.0 mg/L |
| Resolution | 0.1 mg/L |
| Accuracy | ± 0.2 mg/L $\pm 3\%$ of reading at 25 °C |
| Typical EMC Deviation | ± 0.1 mg/L |
| Light Source | Tungsten lamp with narrow band interference filter @ 525 nm |
| Method | Adaptation of the <i>Standard Methods for the Examination of Water and Wastewater, 18th edition</i> , Periodate method. The reaction between manganese and reagents causes a pink tint in the sample. |

REQUIRED REAGENTS

| <u>Code</u> | <u>Description</u> | <u>Quantity</u> |
|-------------|--------------------|-----------------|
| HI 93709A-0 | Citrate | 1 packet |
| HI 93709B-0 | Sodium periodate | 1 packet |

REAGENT SETS

HI 93709-01 Reagents for 100 tests

HI 93709-03 Reagents for 300 tests

For other accessories see page 73.

MEASUREMENT PROCEDURE

- Select the *Manganese HR* method using the procedure described in the *Method Selection* section (see page 12).
- Fill the cuvette with 10 mL of unreacted sample (up to the mark) and replace the cap.
- Place the cuvette into the holder and close the lid.
- Press the **Zero** key. The display will show “-0.0-” when the meter is zeroed and ready for measurement.

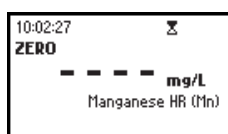
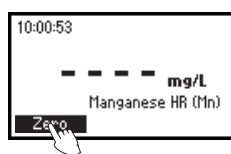
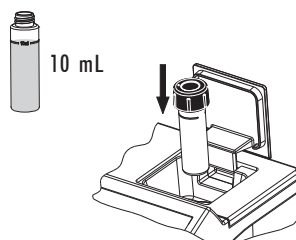

- Remove the cuvette.
- Add the content of one packet of HI 93709A-0 Citrate reagent. Replace the cap and invert to mix with gently movements for 2 minutes.

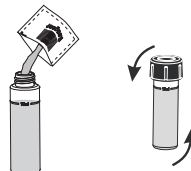

- Add the content of one packet of HI 93709B-0 Sodium Periodate reagent. Replace the cap and invert to mix with gently movements for 2 minutes.

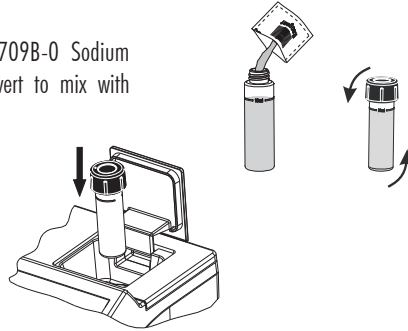

- Reinsert the cuvette into the instrument.

- Press **Timer** and the display will show the countdown prior to the measurement or, alternatively, wait for 1 minute and 30 seconds and press **Read**. When the timer ends the meter will perform the reading. The instrument displays the results in **mg/L of manganese**.

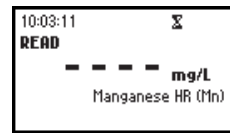

- Press **▲** or **▼** to access the second level functions.
- Press the **Chem Frm** key to convert the result in mg/L of potassium permanganate (KMnO_4) and permanganate (MnO_4^-).

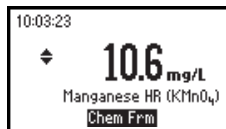
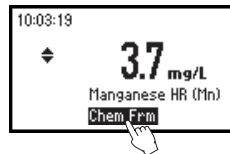

- Press **▲** or **▼** to return to the measurement screen.

INTERFERENCES

Interference may be caused by:

- Calcium above 700 mg/L
- Chloride above 70000 mg/L
- Iron above 5 mg/L
- Magnesium above 100000 mg/L.

MANGANESE LOW RANGE

SPECIFICATIONS

| | |
|--------------|--|
| Range | 0 to 300 µg/L |
| Resolution | 1 µg/L |
| Accuracy | ±10 µg/L ±3% of reading at 25 °C |
| Typical EMC | ±1 µg/L |
| Deviation | |
| Light Source | Tungsten lamp with narrow band interference filter @ 575 nm |
| Method | Adaptation of the PAN Method. The reaction between manganese and the reagents causes an orange tint in the sample. |

REQUIRED REAGENT

| Code | Description | Quantity |
|-------------|-----------------------|---|
| HI 93748A-0 | Ascorbic acid | 2 packets |
| HI 93748B-0 | Alkaline-cyanide sol. | 0.40 mL |
| HI 93748C-0 | 0.1% PAN indicator | 2 mL |
| HI 93703-51 | Dispersing Agent | 4-6 drops (only when necessary, see note) |



REAGENT SETS

HI 93748-01 Reagents for 50 tests

HI 93748-03 Reagents for 150 tests

For other accessories see page 73.

MEASUREMENT PROCEDURE

- Select the *Manganese LR* method using the procedure described in the *Method Selection* section (see page 12).
- Fill one cuvette with 10 mL of deionized water (up to the mark).
 10 mL
- Fill a second cuvette with 10 mL of sample (up to the mark).
 10 mL
- Add the content of one packet of HI 93748A-0 Ascorbic acid to each cuvette, replace the caps and shake gently until completely dissolved.

- Add 0.2 mL of the HI 93748B-0 Alkaline-cyanide reagent solution to each cuvette, replace the caps and invert gently to mix for about 30 seconds.

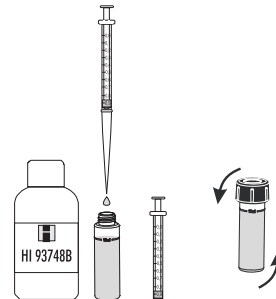

- Add 1 mL of the HI 93748C-0 0.1% PAN indicator solution to each cuvette, replace the caps and shake gently.

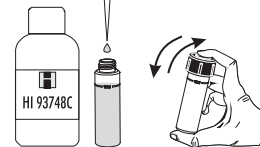

- Add 3 drops of Dispersing Agent (HI 93703-51), to each cuvette replace the caps and invert gently to mix for about 30 seconds.

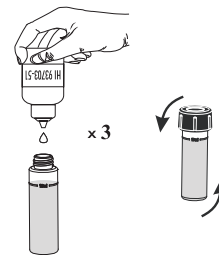

- Place the cuvette with the reacted deionized water (blank) into the holder and close the lid.

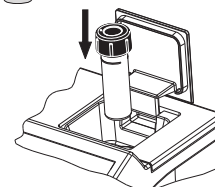

- Press **Timer** and the display will show the countdown prior to zeroing. Alternatively wait for 2 minutes and then press **Zero**. The display will show “-0.0-” when the meter is zeroed and ready for measurement.

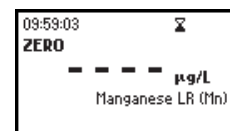
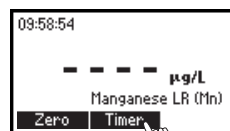

- Insert the second cuvette with the reacted sample into the instrument.

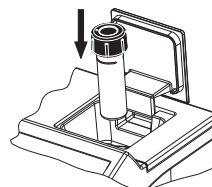

- Press **Read** to start the reading. The instrument displays the results in $\mu\text{g/L}$ of manganese.

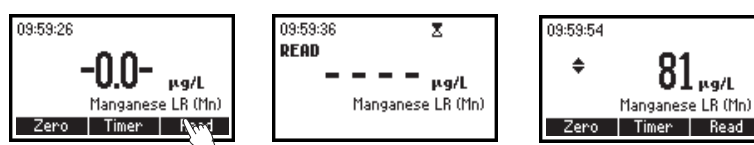

- Press \blacktriangle or \blacktriangledown to access the second level functions.
- Press the **Chem Frm** key to convert the result in mg/L of potassium permanganate (KMnO_4) and permanganate (MnO_4^-).

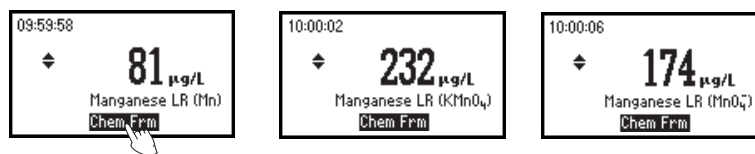

- Press \blacktriangle or \blacktriangledown to return to the measurement screen.

INTERFERENCES

Interference may be caused by:

- Aluminum above 20 mg/L
- Cadmium above 10 mg/L
- Calcium above 200 mg/L as CaCO_3
- Cobalt above 20 mg/L
- Copper above 50 mg/L
- Iron above 10 mg/L
- Lead above 0.5 mg/L
- Magnesium above 100 mg/L as CaCO_3
- Nickel above 40 mg/L
- Zinc above 15 mg/L.

MOLYBDENUM

SPECIFICATIONS

| | |
|---------------------|--|
| Range | 0.0 to 40.0 mg/L |
| Resolution | 0.1 mg/L |
| Accuracy | ± 0.3 mg/L $\pm 5\%$ of reading at 25 °C |
| Typical EMC | ± 0.1 mg/L |
| Deviation | |
| Light Source | Tungsten lamp with narrow band interference filter @ 420 nm |
| Method | Adaptation of the mercaptoacetic acid method. The reaction between molybdenum and the reagents causes a yellow tint in the sample. |

REQUIRED REAGENT

| <u>Code</u> | <u>Description</u> | <u>Quantity</u> |
|-------------|--------------------|-----------------|
| HI 93730A-0 | Reagent A | 1 packet |
| HI 93730B-0 | Reagent B | 1 packet |
| HI 93730C-0 | Reagent C | 1 packet |

REAGENT SETS

HI 93730-01 Reagents for 100 tests

HI 93730-03 Reagents for 300 tests

For other accessories see page 73.

MEASUREMENT PROCEDURE

- Select the *Molybdenum* method using the procedure described in the *Method Selection* section (see page 12).
- Fill the cuvette with 10 mL of unreacted sample (up to the mark) and replace the cap.
- Place the cuvette into the holder and close the lid.

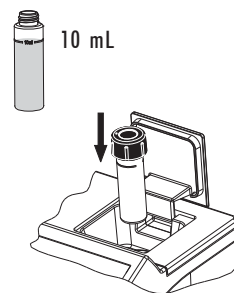

- Press the **Zero** key. The display will show “-0.0-” when the meter is zeroed and ready for measurement.

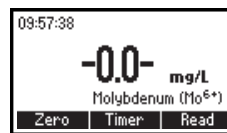
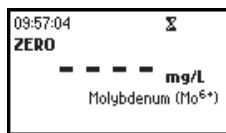
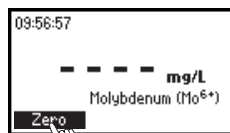

- Fill one graduated mixing cylinder up to the 25 mL mark with the sample.

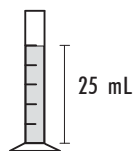

- Add the content of one packet of HI 93730A-0 molybdenum reagent, close the cylinder and invert it several times until completely dissolved.

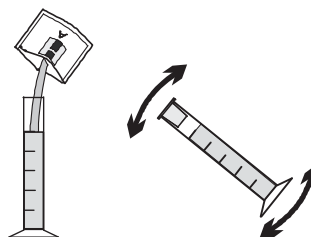

- Add the content of one packet of HI 93730B-0 molybdenum reagent to the cylinder, close and invert it several times until completely dissolved.

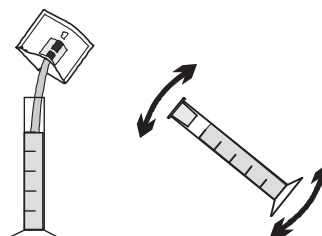

- Add the content of one packet of HI 93730C-0 molybdenum reagent to the cylinder, close and shake it vigorously.

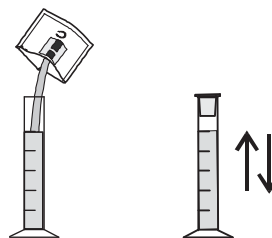

- Fill an empty cuvette with 10 mL of sample up to the mark and replace the cap.

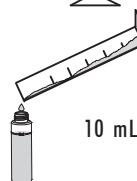

- Insert the cuvette into the instrument.

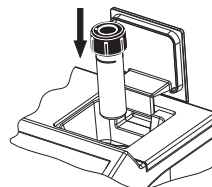

- Press **Timer** and the display will show the countdown prior to the measurement or, alternatively, wait for five minutes and press **Read**. When the timer ends the meter will perform the reading.



The instrument displays concentration in mg/L of molybdenum.

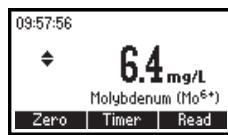

- Press **▲** or **▼** to access the second level functions.
- Press the **Chem Frm** key to convert the result in mg/L of molybdate (MoO_4^{2-}) and sodium molybdate (Na_2MoO_4).

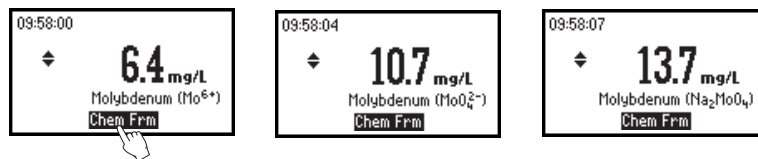

- Press **▲** or **▼** to return to the measurement screen.

INTERFERENCES

Interference may be caused by:

Aluminum above 50 mg/L

Chromium above 1000 mg/L

Copper above 10 mg/L

Iron above 50 mg/L

Nickel above 50 mg/L

Nitrite, as NO_2^-

Sulfate above 200 mg/L

Highly buffered samples or with extreme pH may exceed the buffering capacity of the reagents.

NICKEL HIGH RANGE

SPECIFICATIONS

| | |
|---------------------|---|
| Range | 0.00 to 7.00 g/L |
| Resolution | 0.01 g/L |
| Accuracy | ± 0.07 g/L $\pm 4\%$ of reading at 25 °C |
| Typical EMC | ± 0.02 g/L |
| Deviation | |
| Light Source | Tungsten lamp with narrow band interference filter @ 575 nm |
| Method | Adaptation of the photometric method. The reaction between nickel and the reagent causes a blue tint in the sample. |

REQUIRED REAGENTS

| <u>Code</u> | <u>Description</u> | <u>Quantity</u> |
|-------------|--------------------|-----------------|
| HI 93726-0 | Powder reagent | 1 packet |

REAGENT SETS

HI 93726-01 Reagents for 100 tests

HI 93726-03 Reagents for 300 tests

For other accessories see page 73.

MEASUREMENT PROCEDURE

- Select the *Nickel HR* method using the procedure described in the *Method Selection* section (see page 12).

- Fill the cuvette up to the mark with 10 mL of unreacted sample and replace the cap.



- Place the cuvette into the holder and close the lid.

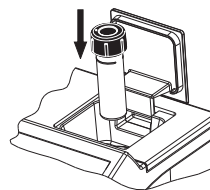

- Press the **Zero** key. The display will show “-0.0-” when the meter is zeroed and ready for measurement.

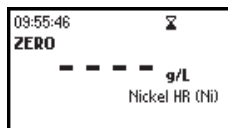
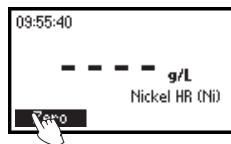

- Remove the cuvette and add the content of one packet of HI 93726-0 reagent. Replace the cap and shake gently until completely dissolved.

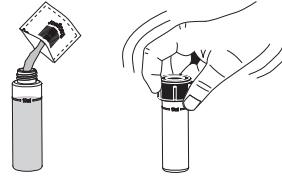

- Reinsert the cuvette into the instrument.

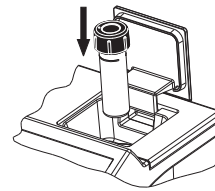

- Press **Timer** and the display will show the countdown prior to the measurement or, alternatively, wait for 1 minute and press **Read**. When the timer ends the meter will perform the reading.

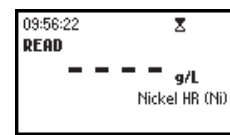

- The instrument displays concentration in g/L of nickel.



INTERFERENCES

Interference may be caused by copper.

NICKEL LOW RANGE

SPECIFICATIONS

| | |
|---------------------|---|
| Range | 0.000 to 1.000 mg/L |
| Resolution | 0.001 mg/L |
| Accuracy | ± 0.010 mg/L $\pm 7\%$ of reading at 25 °C |
| Typical EMC | ± 0.001 mg/L |
| Deviation | |
| Light Source | Tungsten lamp with narrow band interference filter @ 575 nm |
| Method | Adaptation of the PAN method. The reaction between nickel and the reagents causes an orange tint in the sample. |

REQUIRED REAGENTS

| <u>Code</u> | <u>Description</u> | <u>Quantity</u> |
|-------------|---------------------|---|
| HI 93740A-0 | Phthalate-phosphate | 2 packets |
| HI 93740B-0 | 0.3% PAN indicator | 2 mL |
| HI 93740C-0 | EDTA | 2 packets |
| HI 93703-51 | Dispersing Agent | 4-6 drops (only when necessary, see note) |

REAGENT SETS

HI 93740-01 Reagents for 50 tests

HI 93740-03 Reagents for 150 tests

For other accessories see page 73.

MEASUREMENT PROCEDURE

- Select the *Nickel LR* method using the procedure described in the *Method Selection* section (see page 12).

Note: for best results perform your tests between 20-24°C.

- Fill one graduated beaker with 25 mL of deionized water (blank) and another one with 25 mL of sample.
- Add the content of one packet of HI 93740A-0 Phthalate-phosphate reagent to each beaker. Cap and swirl gently until the reagent is dissolved.

Note: If sample contains iron (Fe^{3+}), it is important that all powder be dissolved completely before continuing with following step.

- Add 1 mL of HI 93740B-0 0.3% PAN solution to each beaker, cap and swirl to mix.

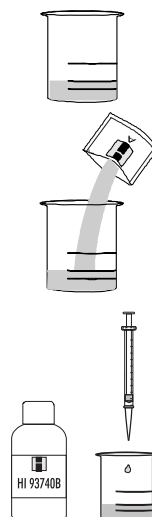

- Press **Timer** and the display will show a countdown prior to adding reagent C or, alternatively, wait for 15 minutes. Add one packet of HI 93740C-0 EDTA reagent to each beaker, cap and swirl to mix until completely dissolved.

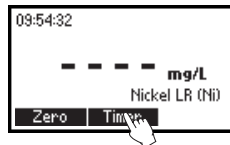

- Fill one cuvette up to the mark with 10 mL of the blank.

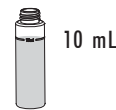

- Place the cuvette into the holder and close the lid.

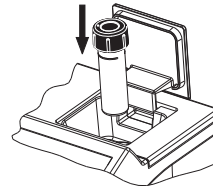

- Press the **Zero** key. The display will show “-0.0-” when the meter is zeroed and ready for measurement.

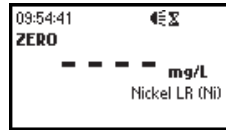
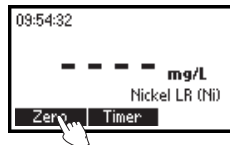

- Fill a second cuvette up to the mark with 10 mL of the reacted sample.



- Insert the second cuvette into the instrument.

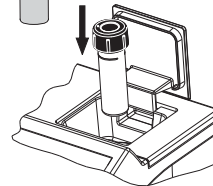

- Press **Read** to start the reading. The instrument displays the results in mg/L of nickel.

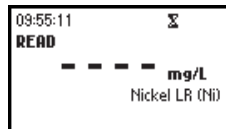

Note: a temperature above 30°C may cause turbidity. In this case, before zeroing and taking readings, add 2-3 drops of Dispersing Agent (HI 93703-51) to each cuvette and swirl until turbidity is removed.

INTERFERENCES

Interference may be caused by:

Co^{2+} must not be present

Fe^{2+} must not be present

Al^{3+} above 32 mg/L

Ca^{2+} above 1000 mg/L (as CaCO_3)

Cd^{2+} above 20 mg/L

Cl^- above 8000 mg/L

Cr^{3+} above 20 mg/L

Cr^{6+} above 40 mg/L

Cu^{2+} above 15 mg/L

F^- above 20 mg/L

Fe^{3+} above 10 mg/L

K^+ above 500 mg/L

Mg^{2+} above 400 mg/L

Mn^{2+} above 25 mg/L

Mo^{6+} above 60 mg/L

Na^+ above 5000 mg/L

Pb^{2+} above 20 mg/L

Zn^{2+} above 30 mg/L

NITRATE

SPECIFICATIONS

| | |
|------------------------------|--|
| Range | 0.0 to 30.0 mg/L |
| Resolution | 0.1 mg/L |
| Accuracy | ± 0.5 mg/L $\pm 10\%$ of reading at 25 °C |
| Typical EMC Deviation | ± 0.1 mg/L |
| Light Source | Tungsten lamp with narrow band interference filter @ 525 nm |
| Method | Adaptation of the cadmium reduction method. The reaction between nitrate and the reagent causes an amber tint in the sample. |

REQUIRED REAGENTS

| <u>Code</u> | <u>Description</u> | <u>Quantity</u> |
|-------------|--------------------|-----------------|
| HI 93728-0 | Powder reagent | 1 packet |

REAGENT SETS

HI 93728-01 Reagents for 100 tests

HI 93728-03 Reagents for 300 tests

For other accessories see page 73.

MEASUREMENT PROCEDURE

- Select the *Nitrate* method using the procedure described in the *Method Selection* section (see page 12).
- Using the pipette, fill the cuvette with 6 ml of sample, up to half of its height, and replace the cap.
- Place the cuvette into the holder and close the lid.
- Press the **Zero** key. The display will show “-0.0-” when the meter is zeroed and ready for measurement.

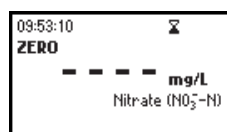
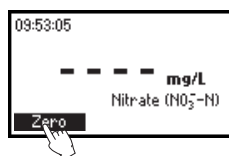
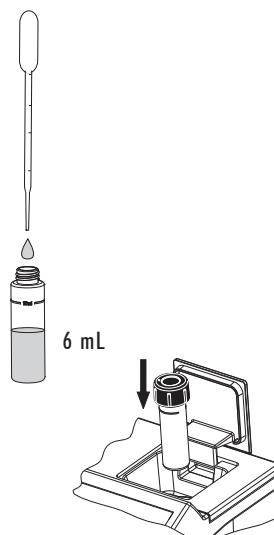

- Remove the cuvette and add the content of one packet of HI 93728-0 reagent.



- Replace the cap and immediately shake vigorously up and down for exactly 10 seconds. Continue to mix by inverting the cuvette gently for 50 seconds, while taking care not to induce air bubbles. Powder will not completely dissolve. Time and way of shaking could sensitively affect the measurement.
- Reinsert the cuvette into the instrument, taking care not to shake it.
- Press **Timer** and the display will show the countdown prior to the measurement or, alternatively, wait for 4 minutes and 30 seconds and press **Read**. When the timer ends the meter will perform the reading. The instrument displays concentration in **mg/L of nitrate-nitrogen**.

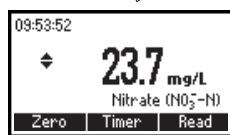
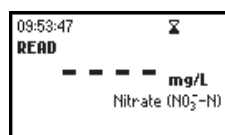
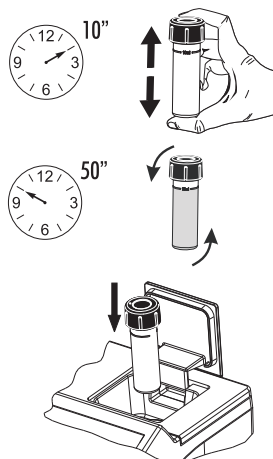

- Press ▲ or ▼ to access the second level functions.
- Press the **Chem Frm** key to convert the result in mg/L of nitrate (NO_3^-).

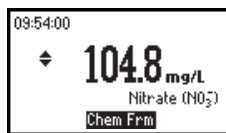
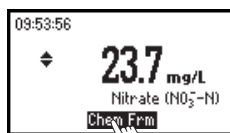

- Press ▲ or ▼ to return to the measurement screen.

INTERFERENCES

Interference may be caused by:

Ammonia and amines, as urea and primary aliphatic amines

Chloride above 100 ppm

Chlorine above 2 ppm

Copper

Iron(III)

Strong oxidizing and reducing substances

Sulfide must be absent

DISSOLVED OXYGEN

SPECIFICATIONS

| | |
|--------------|--|
| Range | 0.0 to 10.0 mg/L |
| Resolution | 0.1 mg/L |
| Accuracy | ± 0.4 mg/L $\pm 3\%$ of reading at 25 °C |
| Typical EMC | ± 0.1 mg/L |
| Deviation | |
| Light Source | Tungsten lamp with narrow band interference filter @ 420 nm |
| Method | Adaptation of the <i>Standard Methods for the Examination of Water and Wastewater, 18th edition</i> , Azide modified Winkler method. The reaction between dissolved oxygen and the reagents causes a yellow tint in the sample. |

REQUIRED REAGENTS

| Code | Description | Quantity |
|-------------|-------------|----------|
| HI 93732A-0 | Reagent A | 5 drops |
| HI 93732B-0 | Reagent B | 5 drops |
| HI 93732C-0 | Reagent C | 10 drops |

REAGENT SET

HI 93732-01 Reagents for 100 tests

HI 93732-03 Reagents for 300 tests

For other accessories see page 73.

MEASUREMENT PROCEDURE

- Select the *Dissolved Oxygen* method using the procedure described in the *Method Selection* section (see page 12).
- Fill one 60 mL glass bottle completely with the unreacted sample.
- Replace the cap and ensure that a small part of the sample spills over.
- Remove the cap and add 5 drops of HI 93732A-0 and 5 drops of HI 93732B-0.
- Add more sample, to fill the bottle completely. Replace the cap again and ensure that a part of the sample spills over. This is to make sure that no air bubbles have been trapped inside, which could alter the reading.
- Invert several times the bottle. The sample becomes orange-yellow and a flocculent agent will appear.

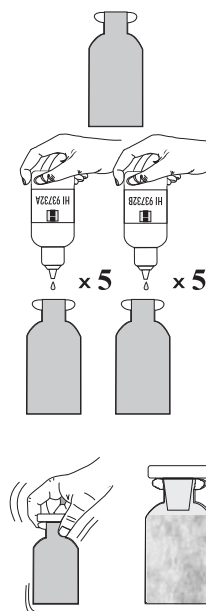

- Let the sample stand and the flocculent agent will start to settle.
- After approximately 2 minutes, when the upper half of the bottle becomes limpid, add 10 drops of HI 93732C-0.
- Replace the cap and invert the bottle until the settled flocculent dissolves completely. The sample is ready for measurement when it is yellow and completely limpid.

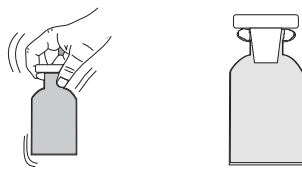
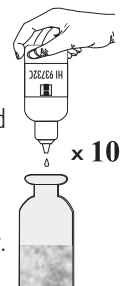

- Fill the cuvette up to the mark with 10 mL of the unreacted (original) sample, and replace the cap. This is the blank.
- Place the cuvette into the holder and close the lid.

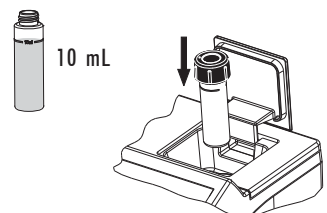

- Press the **Zero** key. The display will show “-0.0-” when the meter is zeroed and ready for measurement.

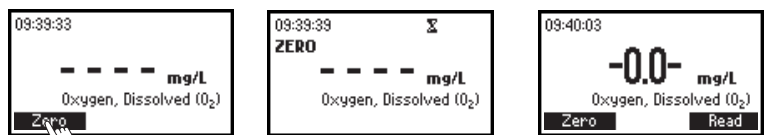

- Remove the cuvette.
- Fill another cuvette up to the mark with 10 mL of the reacted sample and replace the cap.
- Reinsert the cuvette into the instrument.



- Press **Read** to start the reading. The instrument will display the results in **mg/L of dissolved oxygen**.

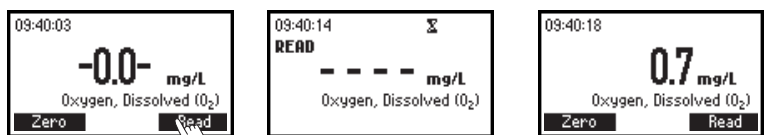

INTERFERENCES

Interferences may be caused by reducing and oxidizing materials.

pH

SPECIFICATIONS

| | |
|--------------|---|
| Range | 6.5 to 8.5 pH |
| Resolution | 0.1 pH |
| Accuracy | ± 0.1 pH at 25 °C |
| Typical EMC | ± 0.1 pH |
| Deviation | |
| Light Source | Tungsten lamp with narrow band interference filter @ 525 nm |
| Method | Adaptation of the Phenol Red method. The reaction with the reagent causes a yellow to red tint in the sample. |

REQUIRED REAGENTS

| Code | Description | Quantity |
|------------|----------------------|----------|
| HI 93710-0 | Phenol Red Indicator | 5 drops |

REAGENT SETS

HI 93710-01 Reagents for 100 pH tests

HI 93710-03 Reagents for 300 pH tests

For other accessories see page 73.

MEASUREMENT PROCEDURE

- Select the *pH* method using the procedure described in the *Method Selection* section (see page 12).
- Fill the cuvette with 10 mL of unreacted sample (up to the mark) and replace the cap.
- Place the cuvette into the holder and close the lid.
- Press the **Zero** key. The display will show “-0.0-” when the meter is zeroed and ready for measurement.

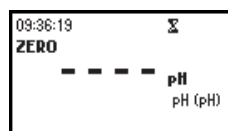
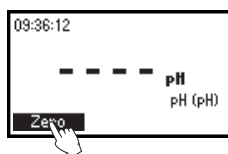
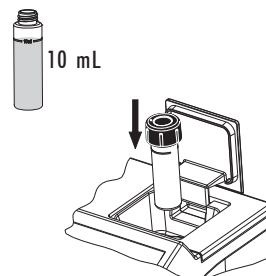

- Remove the cuvette and add 5 drops of HI 93710-0 Phenol Red Indicator. Replace the cap and mix the solution.

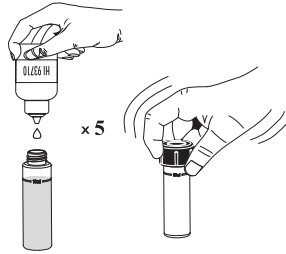

- Reinsert the cuvette into the instrument.

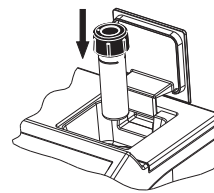

- Press the **Read** key to start the reading. The instrument displays the **pH value**.

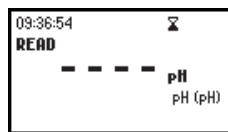
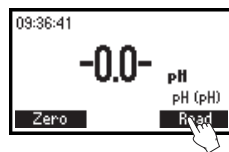

PHOSPHATE HIGH RANGE

SPECIFICATIONS

| | |
|-------------------------|---|
| Range | 0.0 to 30.0 mg/L |
| Resolution | 0.1 mg/L |
| Accuracy | ± 1 mg/L $\pm 4\%$ of reading at 25 °C |
| Typical EMC Dev. | ± 0.1 mg/L |
| Light Source | Tungsten lamp with narrow band interference filter @ 525 nm |
| Method | Adaptation of the <i>Standard Methods for the Examination of Water and Wastewater, 18th edition</i> , Amino Acid method. The reaction between phosphate and reagents causes a blue tint in the sample. |

REQUIRED REAGENTS

| Code | Description | Quantity |
|-------------|-------------|----------|
| HI 93717A-0 | Molybdate | 10 drops |
| HI 93717B-0 | Reagent B | 1 packet |

REAGENT SETS

HI 93717-01 Reagents for 100 tests

HI 93717-03 Reagents for 300 tests

For other accessories see page 73.

MEASUREMENT PROCEDURE

- Select the *Phosphate HR* method using the procedure described in the *Method Selection* section (see page 12).
- Fill the cuvette with 10 mL of unreacted sample (up to the mark) and replace the cap.
- Place the cuvette into the holder and close the lid.

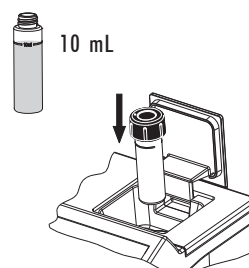

- Press the **Zero** key. The display will show “-0.0-” when the meter is zeroed and ready for measurement.

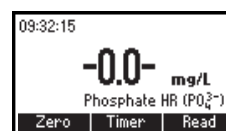
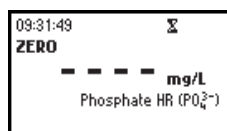
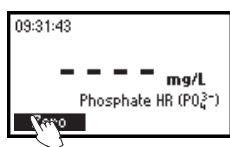

- Remove the cuvette.
- Add 10 drops of HI 93717A-0 Molybdate reagent.



- Add the content of one packet of HI 93717B-0 Phosphate HR Reagent B to the cuvette. Replace the cap and shake gently until completely dissolved.

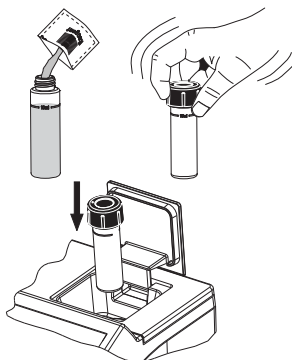

- Reinsert the cuvette into the instrument.

- Press **Timer** and the display will show the countdown prior to the measurement or, alternatively, wait for 5 minutes and press **Read**. When the timer ends the meter will perform the reading. The instrument displays the results in **mg/L of phosphate (PO_4^{3-})**.

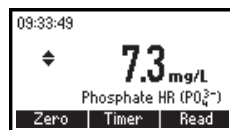
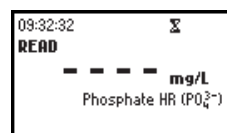
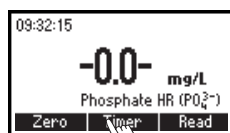

- Press **▲** or **▼** to access the second level functions.
- Press the **Chem Frm** key to convert the result in mg/L of phosphorus (P) and phosphorus pentoxide (P_2O_5).

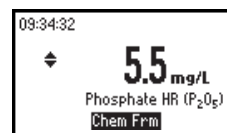
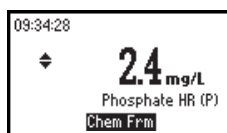
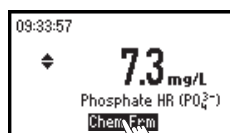

- Press **▲** or **▼** to return to the measurement screen.

INTERFERENCES

Sulfide

Chloride above 150000 mg/L)

Calcium above 10000 mg/L as CaCO_3

Magnesium above 40000 mg/L as CaCO_3

Ferrous iron above 100 mg/L

PHOSPHATE LOW RANGE

SPECIFICATIONS

| | |
|-------------------------|--|
| Range | 0.00 to 2.50 mg/L |
| Resolution | 0.01 mg/L |
| Accuracy | ±0.04 mg/L ±4% of reading at 25 °C |
| Typical EMC Dev. | ±0.01 mg/L |
| Light Source | Tungsten lamp with narrow band interference filter @ 610 nm |
| Method | Adaptation of the Ascorbic Acid method. The reaction between phosphate and the reagent causes a blue tint in the sample. |

REQUIRED REAGENTS

| Code | Description | Quantity |
|------------|----------------|----------|
| HI 93713-0 | Powder reagent | 1 packet |

REAGENT SETS

HI 93713-01 Reagents for 100 tests

HI 93713-03 Reagents for 300 tests

For other accessories see page 73.

MEASUREMENT PROCEDURE

- Select the *Phosphate LR* method using the procedure described in the *Method Selection* section (see page 12).
- Rinse, cap and shake the cuvette several times with unreacted sample. Fill the cuvette with 10 mL of sample up to the mark and replace the cap.
- Place the cuvette into the holder and close the lid.

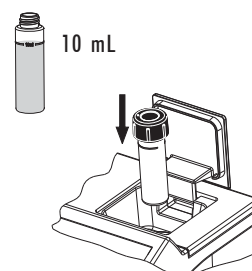

- Press the **Zero** key. The display will show “-0.0-” when the meter is zeroed and ready for measurement.

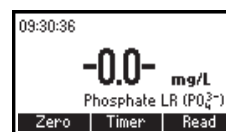
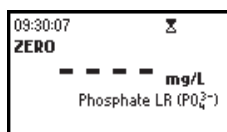
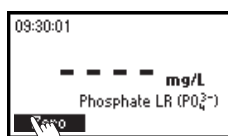

- Remove the cuvette and add the content of one packet of HI 93713-0 reagent. Replace the cap and shake gently (for about 2 minutes) until the powder is completely dissolved.

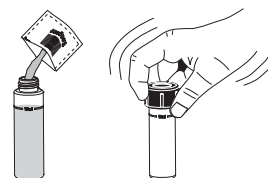

- Reinsert the cuvette into the instrument.

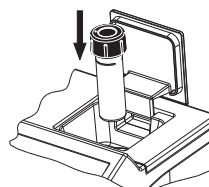

- Press **Timer** and the display will show the countdown prior to the measurement or, alternatively, wait for 3 minutes and press **Read**. When the timer ends the meter will perform the reading. The instrument displays concentration in **mg/L of phosphate (PO_4^{3-})**.

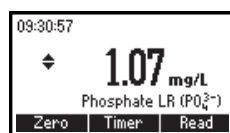
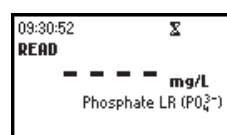
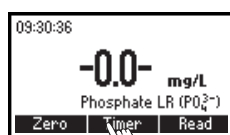

- Press ▲ or ▼ to access the second level functions.
- Press the **Chem Frm** key to convert the result in mg/L of phosphorus (P) and phosphorus pentoxide (P_2O_5).

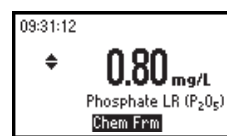
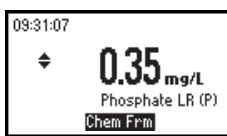
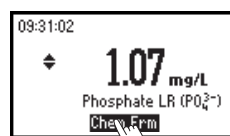

- Press ▲ or ▼ to return to the measurement screen.

INTERFERENCES

Interference may be caused by:

Iron above 50 mg/L

Silica above 50 mg/L

Silicate above 10 mg/L

Copper above 10 mg/L

Hydrogen sulfide, arsenate, turbid sample and highly buffered samples also interfere.

PHOSPHORUS

SPECIFICATIONS

| | |
|-------------------------|---|
| Range | 0.0 to 15.0 mg/L |
| Resolution | 0.1 mg/L |
| Accuracy | ± 0.3 mg/L $\pm 4\%$ of reading at 25 °C |
| Typical EMC Dev. | ± 0.2 mg/L |
| Light Source | Tungsten lamp with narrow band interference filter @ 525 nm |
| Method | Adaptation of the <i>Standard Methods for the Examination of Water and Wastewater, 18th edition</i> , Amino Acid method. The reaction between phosphate and reagents causes a blue tint in the sample. |

REQUIRED REAGENTS

| Code | Description | Quantity |
|-------------|-------------------|----------|
| HI 93706A-0 | Molybdate | 10 drops |
| HI 93706B-0 | Amino Acid Powder | 1 packet |

REAGENT SETS

HI 93706-01 Reagents for 100 tests

HI 93706-03 Reagents for 300 tests

For other accessories see page 73.

MEASUREMENT PROCEDURE

- Select the *Phosphorus* method using the procedure described in the *Method Selection* section (see page 12).
- Fill the cuvette with 10 mL of unreacted sample (up to the mark) and replace the cap.
- Place the cuvette into the holder and close the lid.
- Press the **Zero** key. The display will show “-0.0-” when the meter is zeroed and ready for measurement.

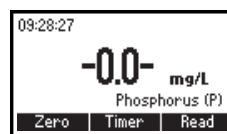
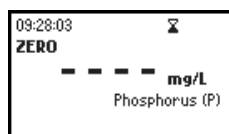
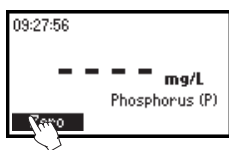
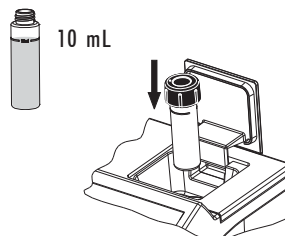

- Remove the cuvette.
- Add 10 drops of HI 93706A-0 Molybdate reagent.



- Add the content of one packet of HI 93706B-0 Phosphorus Reagent B (Amino Acid) to the cuvette. Replace the cap and shake gently until completely dissolved.

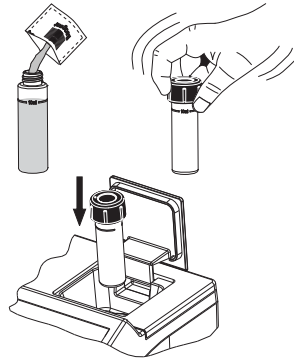

- Reinsert the cuvette into the instrument.

- Press **Timer** and the display will show the countdown prior to the measurement or, alternatively, wait for 5 minutes and press **Read**. When the timer ends the meter will perform the reading. The instrument displays the results in **mg/L of phosphorus (P)**.

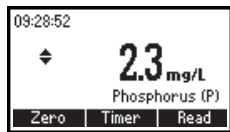
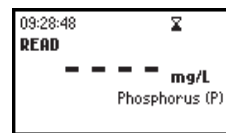
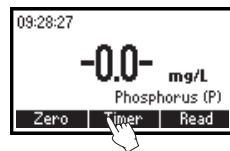

- Press ▲ or ▼ to access the second level functions.
- Press the **Chem Frm** key to convert the result in mg/L of phosphate (PO_4^{3-}) and phosphorus pentoxide (P_2O_5).

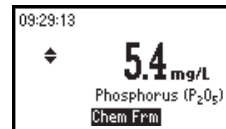
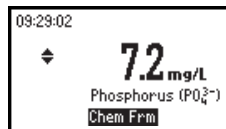
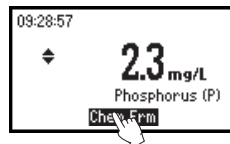

- Press ▲ or ▼ to return to the measurement screen.

INTERFERENCES

Interference may be caused by:

Sulfide

Chloride above 150000 mg/L

Calcium above 10000 mg/L as CaCO_3

Magnesium above 40000 mg/L as CaCO_3

Ferrous iron above 100 mg/L

SILICA

SPECIFICATIONS

| | |
|--------------|---|
| Range | 0.00 to 2.00 mg/L |
| Resolution | 0.01 mg/L |
| Accuracy | ± 0.03 mg/L $\pm 3\%$ of reading at 25 °C |
| Typical EMC | ± 0.01 mg/L |
| Deviation | |
| Light Source | Tungsten lamp with narrow band interference filter @ 610 nm |
| Method | Adaptation of the <i>ASTM Manual of Water and Environmental Technology, D859</i> , Heteropoly Blue method. The reaction between silica and reagents causes a blue tint in the sample. |

REQUIRED REAGENTS

| Code | Description | Quantity |
|-------------|-------------|----------|
| HI 93705A-0 | Molybdate | 6 drops |
| HI 93705B-0 | Citric acid | 1 packet |
| HI 93705C-0 | Amino acid | 1 packet |

REAGENT SETS

HI 93705-01 Reagents for 100 tests

HI 93705-03 Reagents for 300 tests

For other accessories see page 73.

MEASUREMENT PROCEDURE

- Select the *Silica* method using the procedure described in the *Method Selection* section (see page 12).
- Fill the cuvette with 10 mL of unreacted sample (up to the mark).
- Add 6 drops of HI 93705A-0 Molybdate reagent. Replace the cap and swirl the solution.
- Wait for 4 minutes, add the content of one packet of HI 93705B-0 Citric acid reagent and shake until it is completely dissolved.
- Wait for 1 minute. This is the blank.

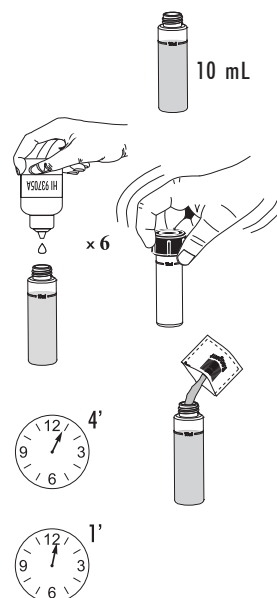

- Place the cuvette into the holder and close the lid.

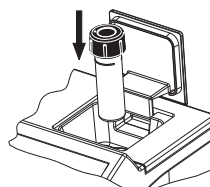

- Press the **Zero** key. The display will show “-0.0-” when the meter is zeroed and ready for measurement.



- Remove the cuvette and add the content of one packet of HI 93705C-0 Amino acid reagent and shake until it is completely dissolved.

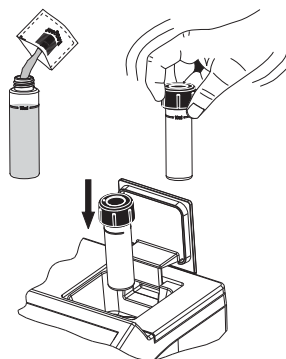

- Reinsert the cuvette into the instrument.

- Press **Timer** and the display will show the countdown prior to the measurement. Alternatively, wait for exactly 3 minutes and press **Read**. When the timer ends the meter will perform the reading. The instrument displays concentration in **mg/L of silica (SiO₂)**.



- Press ▲ or ▼ to access the second level functions.
- Press the **Chem Frm** key to convert the result in mg/L of Silicon (Si).

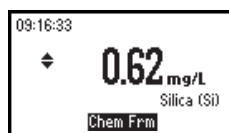
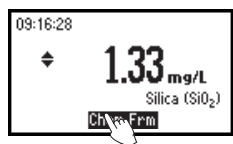

- Press ▲ or ▼ to return to the measurement screen.

INTERFERENCES

Interference may be caused by:

Phosphate above 60 mg/L

Phosphate above 75 mg/L

Sulfide and high concentration of iron

Eliminate color and turbidity interferences by zeroing the meter with the original water sample.

SILVER

SPECIFICATIONS

| | |
|--------------|---|
| Range | 0.000 to 1.000 mg/L |
| Resolution | 0.005 mg/L |
| Accuracy | ± 0.020 mg/L $\pm 5\%$ of reading at 25 °C |
| Typical EMC | ± 0.001 mg/L |
| Deviation | |
| Light Source | Tungsten lamp with narrow band interference filter @ 575 nm. |
| Method | Adaptation of the PAN method. The reaction between silver and reagents causes an orange tint in the sample. |

REQUIRED REAGENTS

| Code | Description | Quantity |
|-------------|---------------------|--|
| HI 93737A-0 | Buffer Reagent A | 1 mL |
| HI 93737B-0 | Buffer Reagent B | 1 mL |
| HI 93737C-0 | Indicator Reagent C | 2 mL |
| HI 93737D-0 | Fixing Reagent D | 2 mL |
| HI 93703-51 | Dispersing Agent | 4-6 drops (only when necessary, see note) |

REAGENT SETS

HI 93737-01 Reagents for 50 tests

HI 93737-03 Reagents for 150 tests

For other accessories see page 73.

MEASUREMENT PROCEDURE

- Select the *Silver* method using the procedure described in the *Method Selection* section (see page 12).

Note: for best results perform your tests between 20-24°C.

- Fill two graduated beakers with 25 mL of sample.

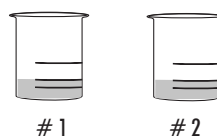

- Add 1.0 mL of HI 93737A-0 Buffer reagent to one beaker (the blank) and swirl gently to mix.

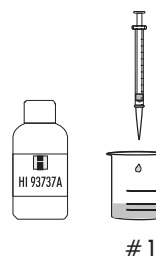

- Add exactly 1.0 mL of HI 93737B-0 Buffer reagent to the second beaker (the sample) and swirl gently to mix. Press **Timer** and the display will show the countdown prior to adding reagent C or, alternatively, wait for 2 minutes.

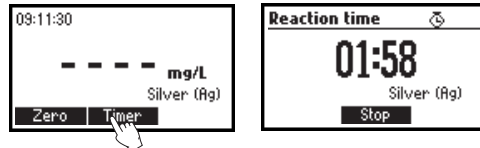

- Then add exactly 1.0 mL of HI 93737C-0 Indicator reagent to each beaker and swirl. Press **Timer** or, alternatively, wait for 2 minutes.

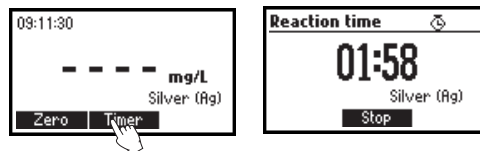

- Then add 1.0 mL of HI 93737D-0 Fixing reagent to each beaker and swirl. Then press **Timer** or, alternatively, wait for 2 minutes to allow reaction to complete.

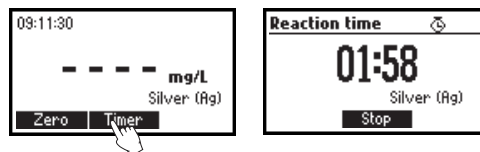

- Fill one cuvette up to the mark with 10 mL of the blank.

- Add 3 drops of Dispersing Agent (HI 93703-51), replace the cap and invert gently to mix for about 10 seconds.

- Place the cuvette into the holder and close the lid.

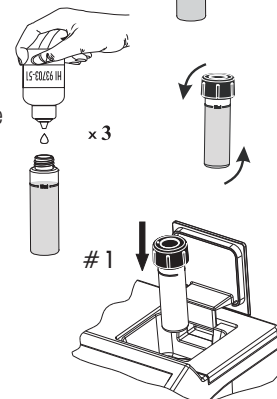
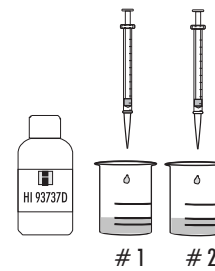
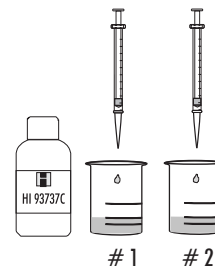
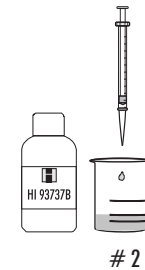

- Press the **Zero** key. The display will show “-0.0-” when the meter is zeroed and ready for measurement.

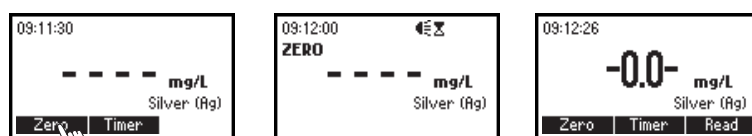

- Fill a second cuvette up to the mark with 10 mL of the reacted sample.



- Add 3 drops of Dispersing Agent (HI 93703-51), replace the cap and invert gently to mix for about 10 seconds.

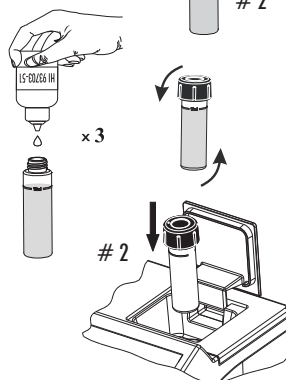

- Insert the second cuvette into the instrument.

- Press **Read** to start the reading. The instrument displays the results in **mg/L of silver**.



INTERFERENCES

Interference may be caused by:

| | |
|---|---|
| Al^{3+} above 30 mg/L | Fe^{2+} above 1.5 mg/L |
| Ca^{2+} above 1000 mg/L as CaCO_3 | Fe^{3+} above 10 mg/L |
| Cd^{2+} above 20 mg/L | K^+ above 500 mg/L |
| Cl^- above 8000 mg/L | Mn^{2+} above 25 mg/L |
| Co^{2+} above 1.5 mg/L | Mg^{2+} above 1000 mg/L as CaCO_3 |
| Cr^{3+} above 20 mg/L | Na^+ above 5000 mg/L |
| Cr^{6+} above 40 mg/L | Ni^{2+} above 1.5 mg/L |
| Cu^{2+} above 15 mg/L | Pb^{2+} above 20 mg/L |
| F^- above 20 mg/L | Zn^{2+} above 30 mg/L |

ZINC

SPECIFICATIONS

| | |
|--------------|--|
| Range | 0.00 to 3.00 mg/L |
| Resolution | 0.01 mg/L |
| Accuracy | ± 0.03 mg/L $\pm 3\%$ of reading at 25 °C |
| Typical EMC | ± 0.01 mg/L |
| Deviation | |
| Light Source | Tungsten lamp with narrow band interference filter @ 575 nm |
| Method | Adaptation of the <i>Standard Methods for the Examination of Water and Wastewater, 18th edition</i> , Zincon method. The reaction between zinc and the reagents causes an orange to a dark violet tint in the sample. |

REQUIRED REAGENT

| Code | Description | Quantity |
|-------------|---------------|----------|
| HI 93731A-0 | Zinc Reagent | 1 packet |
| HI 93731B-0 | Cyclohexanone | 0.5 mL |

REAGENT SETS

HI 93731-01 Reagents for 100 tests

HI 93731-03 Reagents for 300 tests

For other accessories see page 73.

MEASUREMENT PROCEDURE

- Select the *Zinc* method using the procedure described in the *Method Selection* section (see page 12).
- Fill one graduated mixing cylinder up to the 20 mL mark with the sample.
- Add the content of one packet of HI 93731A-0 zinc reagent, close the cylinder and invert several times to mix until completely dissolved.
- Fill one cuvette with 10 mL of the reacted sample up to the mark.

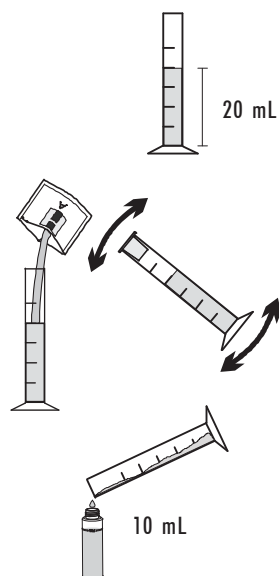

- Place the cap and insert the cuvette into the instrument and close the lid.
- Press the **Zero** key. The display will show “-0.0-” when the meter is zeroed and ready for measurement.

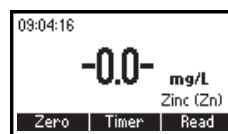
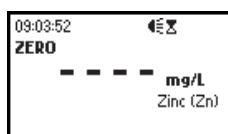
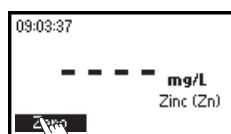
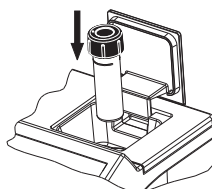

- Remove the cuvette and add 0.5 mL of HI 93731B-0 cyclohexanone to the cuvette.

Note: To prevent any contamination from the polycarbonate cap, prior to replacing it, close the sample cuvette with the supplied HDPE plastic stopper.

- Replace the cap and mix the sample for 15 seconds.

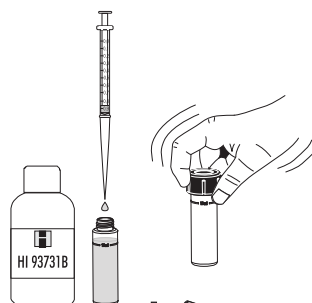

- Insert the sample into the instrument.
- Press **Timer** and the display will show the countdown prior to the measurement or, alternatively, wait for 3 minutes and 30 seconds and press **Read**. When the timer ends the meter will perform the reading.

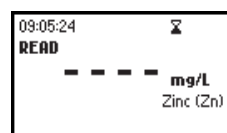
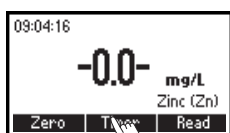
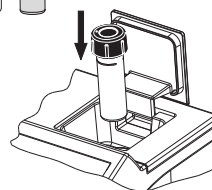

- The instrument displays the results in mg/L of zinc.



INTERFERENCES

Interference may be caused by:

- Aluminum above 6 mg/L
- Cadmium above 0.5 mg/L
- Copper above 5 mg/L
- Iron above 7 mg/L
- Manganese above 5 mg/L
- Nickel above 5 mg/L

ERRORS AND WARNINGS

The instrument shows clear warning messages when erroneous conditions appear and when measured values are outside the expected range. These messages are described below.



No Light: The light source is not functioning properly.



Light Leak: There is an excess amount of ambient light reaching the detector.



Inverted cuvettes: The sample and the zero cuvettes are inverted.



Battery Low: The battery capacity is lower than 10%.



Light Low: The instrument cannot adjust the light level. Please check that the sample does not contain any debris.



Light High: There is too much light to perform a measurement. Please check the preparation of the zero cuvette.

DATA MANAGEMENT

The analyzed data can be managed using Hanna's product HI92000, Windows® Compatible Software.

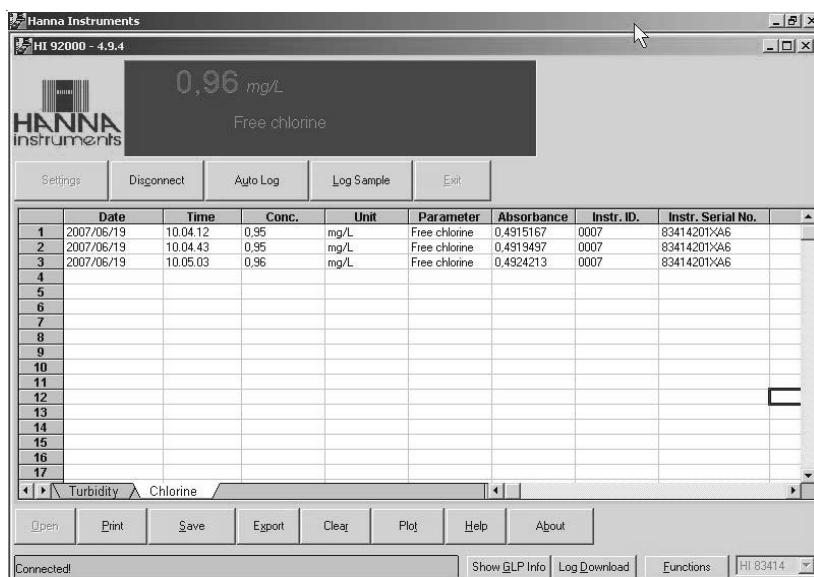

STANDARD METHODS

| <u>Description</u> | <u>Range</u> | <u>Method</u> |
|--------------------|--------------------|---------------------|
| Ammonia MR | 0.00 to 10.00 mg/L | Nessler |
| Ammonia LR | 0.00 to 3.00 mg/L | Nessler |
| Chlorine, Free | 0.00 to 2.50 mg/L | DPD |
| Chlorine, Total | 0.00 to 3.50 mg/L | DPD |
| Copper HR | 0.00 to 5.00 mg/L | Bicinchoninate |
| Copper LR | 0 to 1000 µg/L | Bicinchoninate |
| Fluoride | 0.00 to 2.00 mg/L | SPADNS |
| Iron HR | 0.00 to 5.00 mg/L | Phenantroline |
| Iron LR | 0 to 400 µg/L | TPTZ |
| Manganese HR | 0.0 to 20.0 mg/L | Periodate Oxidation |
| Manganese LR | 0 to 300 µg/L | PAN |
| Molybdenum | 0.0 to 40.0 mg/L | Mercaptoacetic Acid |
| Nickel HR | 0.00 to 7.00 g/L | Photometric |

Windows® is registered Trademark of "Microsoft Co."

| | | |
|-------------------|---------------------|-------------------|
| Nickel LR | 0.000 to 1.000 mg/L | PAN |
| Nitrate | 0.0 to 30.0 mg/L | Cadmium Reduction |
| Oxygen, Dissolved | 0.0 to 10.0 mg/L | Winkler |
| pH | 6.5 to 8.5 pH | Phenol Red |
| Phosphate HR | 0.0 to 30.0 mg/L | Amino Acid |
| Phosphate LR | 0.00 to 2.50 mg/L | Ascorbic Acid |
| Phosphorus | 0.0 to 15.0 mg/L | Amino Acid |
| Silica | 0.00 to 2.00 mg/L | Heteropoly Blue |
| Silver | 0.000 to 1.000 mg/L | PAN |
| Zinc | 0.00 to 3.00 mg/L | Zincon |

ACCESSORIES

REAGENT SETS

| | |
|-------------|-----------------------------------|
| HI 93700-01 | 100 ammonia LR tests |
| HI 93700-03 | 300 ammonia LR tests |
| HI 93701-01 | 100 free chlorine tests (powder) |
| HI 93701-03 | 300 free chlorine tests (powder) |
| HI 93701-F | 300 free chlorine tests (liquid) |
| HI 93701-T | 300 total chlorine tests (liquid) |
| HI 93702-01 | 100 copper HR tests |
| HI 93702-03 | 300 copper HR tests |
| HI 93705-01 | 100 silica tests |
| HI 93705-03 | 300 silica tests |
| HI 93706-01 | 100 phosphorus tests |
| HI 93706-03 | 300 phosphorus tests |
| HI 93709-01 | 100 manganese HR tests |
| HI 93709-03 | 300 manganese HR tests |
| HI 93710-01 | 100 pH tests |
| HI 93710-03 | 300 pH tests |
| HI 93711-01 | 100 total chlorine tests (powder) |
| HI 93711-03 | 300 total chlorine tests (powder) |
| HI 93713-01 | 100 phosphate LR tests |
| HI 93713-03 | 300 phosphate LR tests |
| HI 93715-01 | 100 ammonia MR tests |
| HI 93715-03 | 300 ammonia MR tests |
| HI 93717-01 | 100 phosphate HR tests |
| HI 93717-03 | 300 phosphate HR tests |
| HI 93721-01 | 100 iron HR tests |
| HI 93721-03 | 300 iron HR tests |

| | |
|-------------|----------------------------|
| HI 93726-01 | 100 nickel HR tests |
| HI 93726-03 | 300 nickel HR tests |
| HI 93728-01 | 100 nitrate tests |
| HI 93728-03 | 300 nitrate tests |
| HI 93729-01 | 100 fluoride tests |
| HI 93729-03 | 300 fluoride tests |
| HI 93730-01 | 100 molybdenum tests |
| HI 93730-03 | 300 molybdenum tests |
| HI 93731-01 | 100 zinc tests |
| HI 93731-03 | 300 zinc tests |
| HI 93732-01 | 100 dissolved oxygen tests |
| HI 93732-03 | 300 dissolved oxygen tests |
| HI 93737-01 | 50 silver tests |
| HI 93737-03 | 150 silver tests |
| HI 93740-01 | 50 nickel LR tests |
| HI 93740-03 | 150 nickel LR tests |
| HI 93746-01 | 50 iron LR tests |
| HI 93746-03 | 150 iron LR tests |
| HI 93748-01 | 50 manganese LR tests |
| HI 93748-03 | 150 manganese LR tests |
| HI 95747-01 | 100 copper LR tests |
| HI 95747-03 | 300 copper LR tests |

OTHER ACCESSORIES

| | |
|-------------|---|
| HI 731318 | cloth for wiping cuvettes (4 pcs) |
| HI 731321 | glass cuvettes (4 pcs) |
| HI 731325W | new cap for cuvette (4 pcs) |
| HI 740034 | cap for 100 mL beaker (6 pcs) |
| HI 740036 | 100 mL plastic beaker (6 pcs) |
| HI 740038 | 60 mL glass bottle and stopper |
| HI 740142 | 1 mL graduated syringe |
| HI 740143 | 1 mL graduated syringe (6 pcs) |
| HI 740144 | pipette tip (6 pcs) |
| HI 740157 | plastic refilling pipette (20 pcs) |
| HI 740220 | 25 mL glass cylinders with caps (2 pcs) |
| HI 740226 | 5 mL graduated syringe |
| HI 92000 | Windows compatible software |
| HI 920013 | PC connection cable |
| HI 93703-50 | cuvette cleaning solution (230 mL) |

WARRANTY

All Hanna Instruments meters are warranted for two years against defects in workmanship and materials when used for its intended purpose and maintained according to the instructions.

This warranty is limited to repair or replacement free of charge.

Damages due to accident, misuse, tampering or lack of prescribed maintenance are not covered.

If service is required, contact your dealer. If under warranty, report the model number, date of purchase, serial number and the nature of the failure. If the repair is not covered by the warranty, you will be notified of the charges incurred.

If the instrument is to be returned to Hanna Instruments, first obtain a Returned Goods Authorization Number from the Customer Service Department and then send it with shipment costs prepaid. When shipping any instrument, make sure it is properly packaged for complete protection.

To validate your warranty, fill out and return the enclosed warranty card within 14 days from the date of purchase.

Recommendations for Users

Before using these products, make sure that they are entirely suitable for your specific application and for the environment in which they are used.

Operation of these instruments may cause unacceptable interferences to other electronic equipments, this requiring the operator to take all necessary steps to correct interferences.

Any variation introduced by the user to the supplied equipment may degrade the instruments' EMC performance.

To avoid damages or burns, do not put the instrument in microwave ovens. For yours and the instrument safety do not use or store the instrument in hazardous environments.

Hanna Instruments reserves the right to modify the design, construction and appearance of its products without advance notice.

HANNA LITERATURE

Hanna publishes a wide range of catalogs and handbooks for an equally wide range of applications. The reference literature currently covers areas such as:

- **Water Treatment**
- **Process**
- **Swimming Pools**
- **Agriculture**
- **Food**
- **Laboratory**

and many others. New reference material is constantly being added to the library.

For these and other catalogs, handbooks and leaflets contact your dealer or the Hanna Customer Service Center nearest to you. To find the Hanna Office in your vicinity, check our home page at www.hannainst.com.



Hanna Instruments Inc.
Highland Industrial Park
584 Park East Drive
Woonsocket, RI 02895 USA

Technical Support for Customers
Tel. (800) 426 6287
Fax (401) 765 7575
E-mail tech@hannainst.com
www.hannainst.com

Local Sales and Customer Service Office

